

FEUILLET COMPLÉMENTAIRE

CATALOGUE
GÉNÉRAL

ÉDITION 2022-2023



► Substitutions
► Nouveautés
► Suppressions



IMS

COOPÉRATIVE D'ARTISANS

SOMMAIRE ARTICLES DE SUBSTITUTION OCTOBRE 2023

● AEROTHERMIE DAIKIN BASSE TEMPERATURE.....	page 1
● LIAISON SOLAIRE.....	page 1
● VASE D'EXPANSION.....	page 1
● FILTRE.....	page 1
● SECHE-SERVIETTES.....	page 1
● CHAUFFE-EAU ELECTRIQUE.....	page 1
● MULTISPLIT ATLANTIC R32.....	page 2
● PARE BAIN 1 VOLET.....	page 2
● RECEVEUR.....	page 2
● COLONNE DE DOUCHE THERMOSTATIQUE.....	page 2
● CORPS D'ENCASTREMENT THERMOSTATIQUE.....	page 3
● BATI-AUTOPORTANT.....	page 3
● ABATTANT.....	page 3
● GROHE.....	page 3
● MEUBLE DE SALLE DE BAIN.....	page 4
● EVIER A ENCASTRER SYNTHESE FRANKE.....	page 4
● CUISINETTE.....	page 4
● ELECTROMENAGER.....	page 4
● APPAREILLAGE HAGER.....	page 5
● SOURCE.....	page 5
● ECLAIRAGE INTERIEUR.....	page 5
● ECLAIRAGE EXTERIEUR.....	page 5
● RECEPTION TV.....	page 6
● DOMOTIQUE.....	page 6
● JETLY.....	page 6
● MULTICOUCHE TRA.....	page 6
● MANCHON ISOLANT.....	page 10
● EQUIPEMENT POSTE.....	page 10
● ABRASIF ET DISQUE.....	page 10
● SCIE TREPAN.....	page 10
● VISSERIE ET BOULONNERIE.....	page 11
● PLOT JOUPLAST.....	page 11
● CARRELAGE CÉRAM. TECHNIQUE.....	page 11
● FAIENCE.....	page 11
● SOL SOUPLE.....	page 11
● PROFILE.....	page 11

ARTICLES DE SUBSTITUTION

AEROTHERMIE DAIKIN BASSE TEMPERATURE

GRUPE EXTERIEUR PAC R32



ANCIENNE REFERENCE	DESIGNATION ANCIENNE REF	Article de Substitution
IM170296	GRUPE EXT MONO DAIKIN R32 ALTHERMA 3 T6 ERGA06EV - 050905	IM227910

LIAISON SOLAIRE



ANCIENNE REFERENCE	DESIGNATION ANCIENNE REF	Article de Substitution
A25X0001	LIAISON SOLAIRE INOX 2X16 LONG 15ML 3032067	IM238648

VASE D'EXPANSION

SUPPORT VASE ET VANNE / CLAPET THERMADOR



ANCIENNE REFERENCE	DESIGNATION ANCIENNE REF	Article de Substitution
469ZSM	SUPPORT POTENCE VASE EXPANSION MURAL ZSM	IM243211
469SUPVAS	SUPPORT POUR VASE CYLINDRIQUE	A75F00010

FILTRE

ACCESSOIRE



ANCIENNE REFERENCE	DESIGNATION ANCIENNE REF	Article de Substitution
469Z2126500	JOINT POUR POT FILTRE OVENTROP 2126500	3442166500

SECHE-SERVIETTES

SECHE-SERVIETTES IRSAP SOUL CHAUFFAGE



ANCIENNE REFERENCE	DESIGNATION ANCIENNE REF	Article de Substitution
353SNL055B01	SOUL - 1418X550MM - 633W - BLANC SR L 055B 01 IR 01 NNN	IM238710
353SRL055B01	SOUL - 1418X550MM - 633W - BLANC SR L 055B 01 IR 01 NNN - 053376	IM238710

CHAUFFE-EAU ELECTRIQUE

SERPENTIN



ANCIENNE REFERENCE	DESIGNATION ANCIENNE REF	Article de Substitution
767884409	PECS 200L SERPENTIN MURAL DURALIS 884409	IM239423
767874410	TH PECS VM 150L 874410	IM239422

ARTICLES DE SUBSTITUTION

CHAUFFE-EAU ELECTRIQUE ...

PETITE CAPACITE SOUS EVIER



ANCIENNE REFERENCE	DESIGNATION ANCIENNE REF	Article de Substitution
IM024264	CHAUFFE-EAU CARRE 15L 2000W SOUS EV 221077	IM218841

MULTISPLIT ATLANTIC R32

UNITE INTERIEURE MURALE GAMME TAKAO M2 CONFORT



ANCIENNE REFERENCE	DESIGNATION ANCIENNE REF	Article de Substitution
IM061288	UNITE INT ASYG7KMCC TAKAO M2 CONFORT R32 873194 900/3000 W 3/8-1/4 ATLANTIC	IM238687
IM061289	UNITE INT ASYG9KMCC TAKAO M2 CONFORT R32 873195 900/3200 W 3/8-1/4 ATLANTIC	IM238426

PARE BAIN 1 VOLET

ATELIER DU BAIN



ANCIENNE REFERENCE	DESIGNATION ANCIENNE REF	Article de Substitution
IM070309	PARE BAIN NPB1/VR TR /BLC NPB1SCL	IM234335

RECEVEUR

ONYX SYNTHÈSE



ANCIENNE REFERENCE	DESIGNATION ANCIENNE REF	Article de Substitution
IM074294	RECEVEUR ONYX BLANC 800 X 800 11886 - VENDU SANS BONDE	IM241787
IM007586	RECEVEUR ONYX BLANC 1000*800MM 11851	IM241790
IM025241	RECEVEUR ONYX BLANC 1200*800MM 11853 VENDU SANS BONDE	IM240931



ANCIENNE REFERENCE	DESIGNATION ANCIENNE REF	Article de Substitution
IM022018	RECEVEUR ONYX BLANC 1400*900MM 11873 - VENDU SANS BONDE	IM241795
IM011768	RECEVEUR ONYX BLANC 1600*900MM 11859 - VENDU SANS BONDE	IM241798
IM015353	RECEVEUR ONYX BLANC 1700*800MM 11861	IM239301

COLONNE DE DOUCHE THERMOSTATIQUE

HUBER



ANCIENNE REFERENCE	DESIGNATION ANCIENNE REF	Article de Substitution
IM023761	COLONNE KIRUNA NOIR MAT KRC8403A40 POMME DE TETE 30CM MIT THERMOSTATIQUE	IM176916

ANCIENNE REFERENCE	DESIGNATION ANCIENNE REF	Article de Substitution
IM023765	COLONNE DOUCHE THERMOSTATIQUE ORPHEE PLUS OR.C72026.21 - 044573	IM241892

ARTICLES DE SUBSTITUTION

COLONNE DE DOUCHE THERMOSTATIQUE ...

HUBER ...



ANCIENNE REFERENCE	DESIGNATION ANCIENNE REF	Article de Substitution
IM074382	COLONNE DOUCHE THERMOSTATIQUE GALAXY NOIR REGLABLE H3.C8404A.40 - 047538	IM241893

hansgrohe

ANCIENNE REFERENCE	DESIGNATION ANCIENNE REF	Article de Substitution
59427271000	COLONNE DOUCHE THERMOSTATIQUE CROMETTA E 240 1 JET 27271000	IM010206



ANCIENNE REFERENCE	DESIGNATION ANCIENNE REF	Article de Substitution
IM023762	COLONNE GALAXY H3C8402A21POMME DE TETE-044760 THERMOSTATIQUE	IM176915

CORPS D'ENCASTREMENT THERMOSTATIQUE

FIMA



ANCIENNE REFERENCE	DESIGNATION ANCIENNE REF	Article de Substitution
IM176169	CORPS ENCASTRABLE LAVABO F3600	IM243128

BATI-AUTOPORTANT

SIAMP



ANCIENNE REFERENCE	DESIGNATION ANCIENNE REF	Article de Substitution
IM055049	BÂTI-SUPPORT WC VERSO ORCAB 10005061 PIPE ORIENTABLE	IM200222

ABATTANT

DESCENTE



ANCIENNE REFERENCE	DESIGNATION ANCIENNE REF	Article de Substitution
IM174588	ABATTANT SOFT CLOSE RENOVA NON DECLIPSA 573025000 POUR CUVETTE SUSPENDUE	IM174587

GROHE

SERIE BAUEDGE



ANCIENNE REFERENCE	DESIGNATION ANCIENNE REF	Article de Substitution
IM193042	MITIGEUR BAIN/DOUCHE BAUEDGE 23914001	IM070799
B30000001	MITIGEUR LAVABO BAULOOP 23335000 GROHE	IM178854
IM012115	BAULOOP MITIGEUR LAVABO M 23762000	IM178948

ARTICLES DE SUBSTITUTION

GROHE ...

SERIE BAUEDGE ...



ANCIENNE REFERENCE	DESIGNATION ANCIENNE REF	Article de Substitution
IM012116	BAULOOP MITIGEUR LAVABO L 23763000	IM178810
56823340000	MITIGEUR DOUCHE BAULOOP C2 23340000	IM178949
IM059878	MITIGEUR BAIN / DOUCHE BAULOOP 23341000	IM178950

MEUBLE DE SALLE DE BAIN

SOUS VASQUE



ANCIENNE REFERENCE	DESIGNATION ANCIENNE REF	Article de Substitution
IM009672	PLAN MUNDO SYNTHÈSE 1VASQUE BLANC 60CM 041702	IM234419
IM009674	PLAN MUNDO SYNTHÈSE 1VASQUE BLANC 80CM 553034	IM235737
IM009676	PLAN MUNDO SYNTHÈSE 2VASQUES BLANC 120CM 553039	IM238847

EVIER A ENCASTRER SYNTHÈSE FRANKE

SIRIUS



ANCIENNE REFERENCE	DESIGNATION ANCIENNE REF	Article de Substitution
581095485	EVIER S2D651 SIRIUS 1C1/2 1E BLANC ARTIC095485	IM193824
IM201366	CNG 611-XL NOIR MAT MANU 913850	IM240544

CUISINETTE



ANCIENNE REFERENCE	DESIGNATION ANCIENNE REF	Article de Substitution
IM201598	MEUBLE CUISINETTE 120CM BLANC 1PORTE MC12055601P	IM242242

ELECTROMENAGER



ANCIENNE REFERENCE	DESIGNATION ANCIENNE REF	Article de Substitution
IM225145	REFRIG. FRI ROTT92BF T TOP 90L(CL F)H83,1XL47,4XP44,7CM BLANC	IM225107
IM183777	FRIGO TOP CANDY CCTOS542WHN T TOP 109L(95+14)(CL F)H85XL55XP58 4* PO	IM225145

ARTICLES DE SUBSTITUTION

APPAREILLAGE HAGER

ACCESSOIRE



ANCIENNE REFERENCE	DESIGNATION ANCIENNE REF	Article de Substitution
IM059259	ESSENSYA GRIFFE WK696	IM170125

SOURCE

LED



ANCIENNE REFERENCE	DESIGNATION ANCIENNE REF	Article de Substitution
D70X00029	LAMPE LED GU10 4,2W 345LM 3000K 230V 0029160	IM195557

ECLAIRAGE INTERIEUR

SPOT ENCASTRE



ANCIENNE REFERENCE	DESIGNATION ANCIENNE REF	Article de Substitution
IM056159	ST SPOT 500 3T IP44 BLA 0005370	IM239093
IM055818	ST SPOT 500 3T IP44 BLA 0005371	IM239093



ANCIENNE REFERENCE	DESIGNATION ANCIENNE REF	Article de Substitution
IM056157	ST SPOT 610 3T IP65 BLA 0005565	IM238644
IM055817	SPOT LED 6,5W 600LM 4000K BF IP65 AUTO 0005374	IM238644

ANCIENNE REFERENCE	DESIGNATION ANCIENNE REF	Article de Substitution
IM239620	SPOT OBICO 9W 720LM 830/840 OR IP65 DIM 0005350	0005350



ANCIENNE REFERENCE	DESIGNATION ANCIENNE REF	Article de Substitution
IM169431	LAMPE LED E27 8,5W 806LM 2700K 230V 326842	IM235393
IM167715	LAMPE LED E27 8,5W 806LM 4000K 230V 973381	IM235392

ECLAIRAGE EXTERIEUR

HUBLLOT



ANCIENNE REFERENCE	DESIGNATION ANCIENNE REF	Article de Substitution
IM072956	HUBLLOT LED 10W 4000K 1200LM IP55 DETEC 820257	IM229895

ARTICLES DE SUBSTITUTION

RECEPTION TV

KIT



ANCIENNE REFERENCE	DESIGNATION ANCIENNE REF	Article de Substitution
IM024534	KIT PREAMPLI UHF/VHF+ALIM 35DBCANAL 21/4 KIT35PLUS2148	IM241922

ANCIENNE REFERENCE	DESIGNATION ANCIENNE REF	Article de Substitution
711SVE06BIS	REPARTITEURS 6 SORTIES S6WN	IM242472

DOMOTIQUE

DELTA



ANCIENNE REFERENCE	DESIGNATION ANCIENNE REF	Article de Substitution
7196700103	TYDOM 1.0 - PILOTER VOS OBJETS CONNECTES 6700103	6700103

JETLY

POMPE IMMERGEE



ANCIENNE REFERENCE	DESIGNATION ANCIENNE REF	Article de Substitution
389152602	POMPE IMMERGEE DIVERTRON 1200-X 230V 152602	IM200937

MULTICOUCHE TRA

TUBE



ANCIENNE REFERENCE	DESIGNATION ANCIENNE REF	Article de Substitution
IM196834	TUBE MULTICOUCHE NU 25X2-5 - 50 ML 06.06.250	IM231320

ANCIENNE REFERENCE	DESIGNATION ANCIENNE REF	Article de Substitution
IM196838	TUBE MULTICOUCHE BARRE 4 ML 25X2-5 06.06.025	IM231321

ANCIENNE REFERENCE	DESIGNATION ANCIENNE REF	Article de Substitution
IM196846	TUBE MULTICOUCHE ISOLE 25X2.5 50ML 10MM 06.10.251	IM231322

ARTICLES DE SUBSTITUTION

MULTICOUCHE TRA ...

RACCORD FIXE MALE



ANCIENNE REFERENCE	DESIGNATION ANCIENNE REF	Article de Substitution
IM196848	RACCORD MULTICOUCHE FIXE MALE 16-3/8 475.64.161	IM231323
IM196849	RACCORD MULTICOUCHE FIXE MALE 16-1/2 475.64.162	IM231324
IM196850	RACCORD MULTICOUCHE FIXE MALE 16-3/4 475.64.163	IM231325
IM196851	RACCORD MULTICOUCHE FIXE MALE 20-1/2 475.64.201	IM231326
IM196852	RACCORD MULTICOUCHE FIXE MALE 20-3/4 475.64.202	IM231327
IM196853	RACCORD MULTICOUCHE FIXE MALE 25-3/4 475.64.252	IM231328
IM196854	RACCORD MULTICOUCHE FIXE MALE 25-1 475.64.253	IM231329
IM196855	RACCORD MULTICOUCHE FIXE MALE 32-1 475.64.321	IM231330

RACCORD FIXE FEMELLE



ANCIENNE REFERENCE	DESIGNATION ANCIENNE REF	Article de Substitution
IM196856	RACCORD MULTICOUCHE FIXE FEMELLE 16-1/2 475.68.162	IM231331
IM196857	RACCORD MULTICOUCHE FIXE FEMELLE 20-1/2 475.68.201	IM231332
IM196858	RACCORD MULTICOUCHE FIXE FEMELLE 20-3/4 475.68.202	IM231333
IM196859	RACCORD MULTICOUCHE FIXE FEMELLE 25-3/4 475.68.251	IM231334
IM196860	RACCORD MULTICOUCHE FIXE FEMELLE 25-1 475.68.252	IM231335
IM196861	RACCORD MULTICOUCHE FIXE FEMELLE 32-1 475.68.321	IM231336

COUDE TERMINAL MALE



ANCIENNE REFERENCE	DESIGNATION ANCIENNE REF	Article de Substitution
IM196862	COUDE MULTICOUCHE TERMINAL MALE 16-1/2 476.14.162	IM231337
IM196863	COUDE MULTICOUCHE TERMINAL MALE 20-1/2 476.14.201	IM231338

COUDE FEMELLE FIXE



ANCIENNE REFERENCE	DESIGNATION ANCIENNE REF	Article de Substitution
IM196864	COUDE MULTICOUCHE FEM FIXE 16-1/2 476.18.162	IM231339
IM196865	COUDE MULTICOUCHE FEM FIXE 20-1/2 476.18.201	IM231340
IM196866	COUDE MULTICOUCHE FEM FIXE 20-3/4 476.18.202	IM231382
IM196867	COUDE MULTICOUCHE FEM FIXE 25-3/4 476.18.251	IM231341
IM196868	COUDE MULTICOUCHE FEM FIXE 32-1 476.18.322	IM231342

ARTICLES DE SUBSTITUTION

MULTICOUCHE TRA ...

TE SORTIE FEMELLE



ANCIENNE REFERENCE	DESIGNATION ANCIENNE REF	Article de Substitution
IM196869	TE MULTICOUCHE SORTIE FEMELLE 16-1/2 477.18.161	IM231343
IM196870	TE MULTICOUCHE SORTIE FEMELLE 20-1/2 477.18.201	IM231344
IM196871	TE MULTICOUCHE SORTIE FEMELLE 25-3/4 477.18.252	IM231345
IM196872	TE MULTICOUCHE SORTIE FEMELLE 32-3/4 477.18.321	IM231346

RACCORD LIBRE



ANCIENNE REFERENCE	DESIGNATION ANCIENNE REF	Article de Substitution
IM196873	RACCORD MULTICOUCHE EC LIBRE F16X2-1/2 475.47.162	IM231347
IM196874	RACCORD MULTICOUCHE EC LIBRE F20X2-1/2 475.47.201	IM231348
IM196875	RACCORD MULTICOUCHE EC LIBRE F20X2-3/4 475.47.202	IM231349
IM196876	RACCORD MULTICOUCHE EC LIBRE F25-3/4 475.47.251	IM231350
IM196877	RACCORD MULTICOUCHE EC LIBRE F25X2,5-1 475.47.252	IM231351
IM196878	RACCORD MULTICOUCHE EC LIBRE F32-1 475.47.321	IM231352

COUDE MURAL



ANCIENNE REFERENCE	DESIGNATION ANCIENNE REF	Article de Substitution
IM196879	COUDE MULTICOUCHE MURAL 16-1/2 476.52.161	IM231353
IM196880	COUDE MULTICOUCHE MURAL 20-1/2 476.52.201	IM231354

COUDE



ANCIENNE REFERENCE	DESIGNATION ANCIENNE REF	Article de Substitution
IM196881	COUDE MULTICOUCHE 16 476.77.160	IM231355
IM196882	COUDE MULTICOUCHE 20 476.77.200	IM231356
IM196883	COUDE MULTICOUCHE 25 476.77.250	IM231357
IM196884	COUDE MULTICOUCHE 32 476.77.320	IM231358

ARTICLES DE SUBSTITUTION

MULTICOUCHE TRA ...

TE EGAL



ANCIENNE REFERENCE	DESIGNATION ANCIENNE REF	Article de Substitution
IM196885	TE MULTICOUCHE EGAL 16-16-16 477.77.160	IM231359
IM196886	TE MULTICOUCHE EGAL 20-20-20 477.77.200	IM231360
IM196887	TE MULTICOUCHE EGAL 25-25-25 477.77.250	IM231383
IM196888	TE MULTICOUCHE EGAL 32-32-32 477.77.320	IM231361

TE REDUIT



ANCIENNE REFERENCE	DESIGNATION ANCIENNE REF	Article de Substitution
IM196889	TE MULTICOUCHE REDUIT 16-20-16 477.76.163	IM231362
IM196890	TE MULTICOUCHE REDUIT 20-16-16 477.76.202	IM231363
IM196891	TE MULTICOUCHE REDUIT 20-16-20 477.76.203	IM231364
IM196892	TE MULTICOUCHE REDUIT 20-20-16 477.76.204	IM231365
IM196893	TE MULTICOUCHE REDUIT 20-25-20 477.76.206	IM231366
IM196894	TE MULTICOUCHE REDUIT 25-16-25 477.76.253	IM231367
IM196895	TE MULTICOUCHE REDUIT 25-20-20 477.76.255	IM231368
IM196896	TE MULTICOUCHE REDUIT 25-20-25 477.76.256	IM231369
IM196897	TE MULTICOUCHE REDUIT 32-20-32 477.76.323	IM231370
IM196898	TE MULTICOUCHE REDUIT 32-25-32 477.76.324	IM231371

MANCHON



ANCIENNE REFERENCE	DESIGNATION ANCIENNE REF	Article de Substitution
IM196899	MANCHON MULTICOUCHE 16-16 475.77.160	IM231372
IM196900	MANCHON MULTICOUCHE 20-20 475.77.200	IM231373
IM196901	MANCHON MULTICOUCHE 25-25 475.77.250	IM231374
IM196902	MANCHON MULTICOUCHE 32-32 475.77.320	IM231375
IM196903	MANCHON MULTICOUCHE REDUIT 16-25 475.76.162	IM231376
IM196904	MANCHON MULTICOUCHE REDUIT 16-20 475.76.161	IM231377
IM196905	MANCHON MULTICOUCHE REDUIT 20-25 475.76.201	IM231378
IM196906	MANCHON MULTICOUCHE REDUIT 32-20 475.76.214	IM231379
IM196907	MANCHON MULTICOUCHE REDUIT 32-25 475.76.251	IM231380

PLATINE DE FIXATION



ANCIENNE REFERENCE	DESIGNATION ANCIENNE REF	Article de Substitution
IM196910	PLATINE DE FIXATION (U/TH) 47500162	IM231381

ARTICLES DE SUBSTITUTION

MULTICOUCHE TRA ...

RACCORD ECROU LIBRE



ANCIENNE REFERENCE	DESIGNATION ANCIENNE REF	Article de Substitution
IM197658	RACCORD ECROU FEM LIBRE 16 3/4" (U/TH) 37547163	IM238224
IM198006	RACCORD ECROU FEM LIBRE 16 3/8" (U/TH) 37547161	IM238225

COUDE ECROU LIBRE



ANCIENNE REFERENCE	DESIGNATION ANCIENNE REF	Article de Substitution
IM223365	COUDE MULTICOUCHE EC LIBRE F16-1/2 476.38.162	IM236343
IM223366	COUDE MULTICOUCHE EC LIBRE F16-3/4 476.38.163	IM236344
IM223367	COUDE MULTICOUCHE EC LIBRE F20-1/2 476.38.201	IM236345
IM223368	COUDE MULTICOUCHE EC LIBRE F20-3/4 476.38.202	IM236347

MANCHON ISOLANT

NON FENDU

ANCIENNE REFERENCE	DESIGNATION ANCIENNE REF	Article de Substitution
391EC09X028	MANCHON ISOLANT 9MM D28 ST09X028	IM176507

EQUIPEMENT POSTE

CHALUMEAU



ANCIENNE REFERENCE	DESIGNATION ANCIENNE REF	Article de Substitution
32245200	AUTOFLAM II SI 0 764510	IM228228

ABRASIF ET DISQUE

DISQUE D PRO-CERAMIC



ANCIENNE REFERENCE	DESIGNATION ANCIENNE REF	Article de Substitution
4372608615020	DISQUE D BEST FOR CERAMIC 76 MM	IM240880

SCIE TREPAN

SCIE TREPAN CARBURE 67MM



ANCIENNE REFERENCE	DESIGNATION ANCIENNE REF	Article de Substitution
IM053831	SCIE TREPAN EXP. CARBURE MULTIMAT. Ø67MM 2608900432	IM024050

ARTICLES DE SUBSTITUTION

VISSERIE ET BOULONNERIE

VIS PENTURE TORX



ANCIENNE REFERENCE	DESIGNATION ANCIENNE REF	Article de Substitution
IM018842	VIS PENTURE TORX 6X30 BTE 100 IM018842	IM234117

PLOT JOUPLAST



ANCIENNE REFERENCE	DESIGNATION ANCIENNE REF	Article de Substitution
IM179355	HR 200X200 PLAQUE A DALLE ESSENTIEL	IM242877

CARRELAGE CÉRAM. TECHNIQUE

CARRELAGE CÉRAM TECHNIQUE 30X30



ANCIENNE REFERENCE	DESIGNATION ANCIENNE REF	Article de Substitution
IM006247	CX 30X30 TAURUS GRANIT TUNIS 61 S U4P4	IM241780

FAIENCE

ANCIENNE REFERENCE	DESIGNATION ANCIENNE REF	Article de Substitution
IM016198	FAIENCE 30X60 BLANC MAT RECT	IM239332

SOL SOUPLE

PLINTHE

ANCIENNE REFERENCE	DESIGNATION ANCIENNE REF	Article de Substitution
IM174935	PLINTHE BOIS MDF ENROBE BLANC 14X80X2400 G007184 BORD ARRONDI	IM232975

PROFILE

CHANT DROIT



ANCIENNE REFERENCE	DESIGNATION ANCIENNE REF	Article de Substitution
IM075179	PROFILE CHANT DROIT PVC BLANC EP 80MM PT08-01	IM228202
IM075183	PROFILE CHANT DROIT PVC BLANC EP 100MM PT10-01	IM228216
IM075186	PROFILE CHANT DROIT PVC BLANC EP 125MM PT125-01	IM238744

SOMMAIRE NOUVEAUX PRODUITS OCTOBRE 2023

■ CHAUFFAGE

page 12

- DUOTEN NOIR RAL 9005..... page 12
- SYSTEME CONCENTRIQUE BIOTEN ETANCHE..... page 12
- SECHE-SERVIETTES..... page 13
- CHAUFFE-EAU ELECTRIQUE..... page 20

■ SANITAIRE

page 21

- COLONNE DE DOUCHE THERMOSTATIQUE..... page 21
- PACK CUVETTE..... page 22
- PACK WC SOL..... page 22
- PACK WC SURELEVE..... page 22
- ROBINET FLOTTEUR..... page 22
- RAMON SOLER..... page 22
- CUISINETTE..... page 23

■ ELECTRICITE

page 25

- GAINE PREFILEE..... page 25
- APPAREILLAGE LEGRAND..... page 25
- ECLAIRAGE INTERIEUR..... page 25
- ECLAIRAGE EXTERIEUR..... page 26
- DOMOTIQUE..... page 26
- PILE ET BATTERIE..... page 26

■ FOURNITURES GENERALES

page 27

- ETANCHEITE..... page 27
- GRAISSE ET LUBRIFIANT..... page 27
- PLOMBERIE - RACCORD..... page 27
- MANCHON ISOLANT..... page 27

■ CARRELAGE

page 28

- ECOULEMENT..... page 28
- PROFILE..... page 28
- NATTE..... page 28
- CONSOMMABLE..... page 28
- NETTOYAGE ET PROTECTION..... page 29
- CARREAU DE SOL INTERIEUR IMITATION BOIS..... page 30

CHAUFFAGE

DUOTEN NOIR RAL 9005

- CONDUIT DE FINITION



REFERENCE IMS	CODE FOURNISSEUR	DESIGNATION	HT €
IM003476	555115	CONDUIT DE FINITION NOIR D150/200 DUOTEN	162,28

SYSTEME CONCENTRIQUE BIOTEN ETANCHE

- TERMINAL CHEMINEE NOIR BIOTEN 80/125 MM



REFERENCE IMS	CODE FOURNISSEUR	DESIGNATION	HT €
468275033	275033	TERMINAL C3 INOX NOIR 80	164,42



REFERENCE IMS	CODE FOURNISSEUR	DESIGNATION	HT €
IM073627	477680	DEFLECTEUR NOIR P/TERMINAL BIOTEN 80/125	41,15

● SECHE-SERVIETTES IRSAP SOUL-S CHAUFFAGE CENTRAL

Installation

H	L	X
mm	mm	mm
924	550	392
1176	550	644
1540	550	1008
1848	550	1316

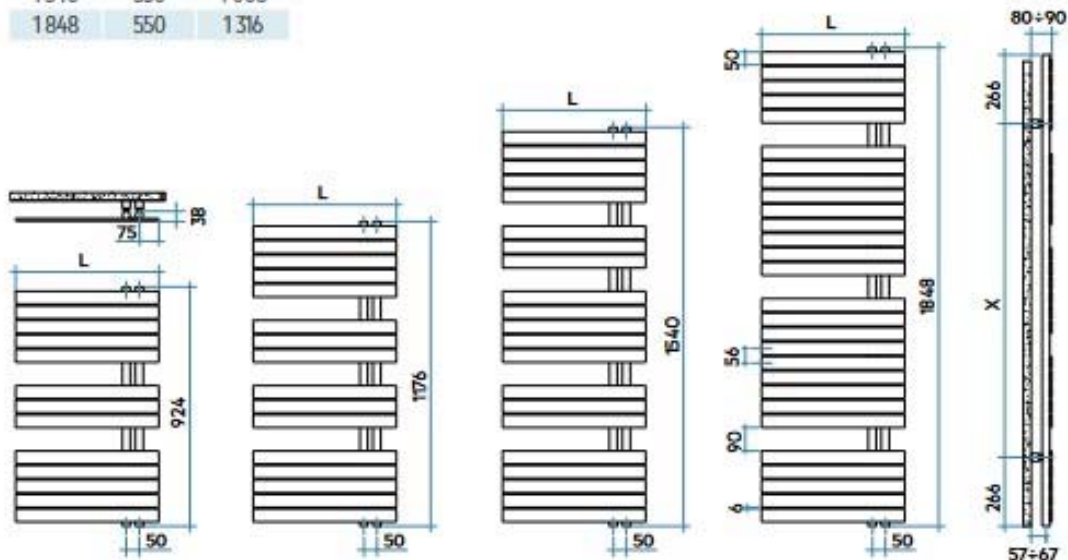

COLLECTEUR DROITE OU GAUCHE

REFERENCE IMS	CODE FOURNISSEUR	DESIGNATION		HT €
IM239250	URP055B01IR01NNN	SOUL_S H. 924X550MM - 408W - BLANC	NS	315,00
IM238706	URS055B01IR01NNN	SOUL_S - 1176X550MM - 505W - BLANC	NS	348,75
IM238710	URM055B01IR01NN	SOUL_S - 1540X550MM - 655W - BLANC	NS	226,43
IM238451	URE055B01IR01NNN	SOUL_S - 1848X550MM - 825W - BLANC	NS	536,25

Raccordement et dimensions avec robinetterie IRSAP (en option) :

Radiateur réversible : collecteur droite ou gauche sur une seule et même référence

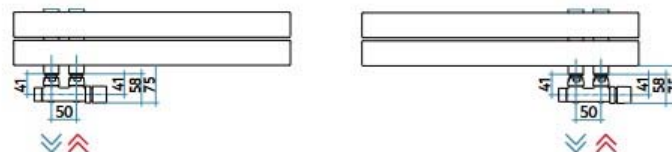

CHAUFFAGE

SECHE-SERVIETTES ...

- SECHE-SERVIETTES IRSAP SOUL-S BOOSTER CHAUFFAGE CE



Installation

H	L	X
mm	mm	mm
1216	550	644
1580	550	1008
1888	550	1316

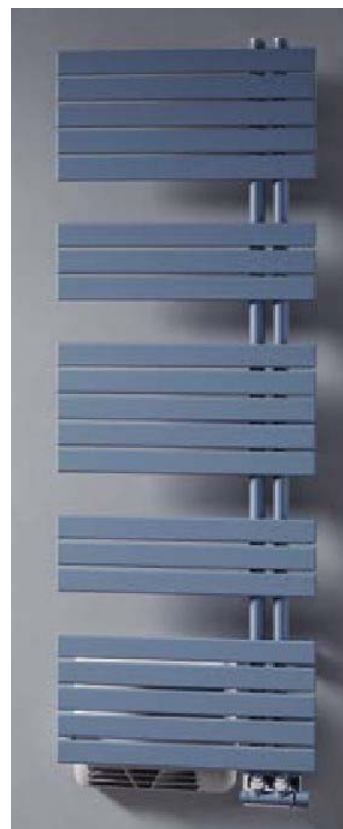
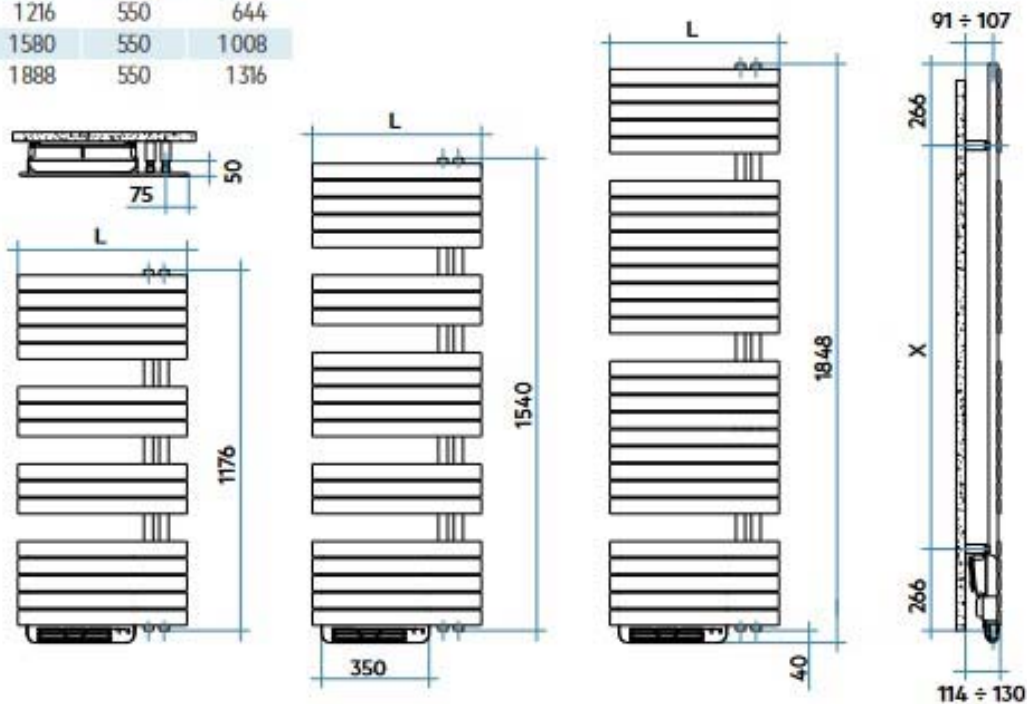

COLLECTEUR A DROITE

REFERENCE IMS	CODE FOURNISSEUR	DESIGNATION		HT €
IM239251	UBS055B01A401NNN	SOUL_S BOOSTER 1216X550MM 505+1000W BLC	NS	593,75
IM239252	UBM055B01A401NNN	SOUL_S BOOSTER 1580X550MM 655+1000W BLANC	NS	660,00
IM239253	UBE055B01A401NNN	SOUL_S BOOSTER 1888X550MM 825+1000W BLANC	NS	790,31

COLLECTEUR A GAUCHE

REFERENCE IMS	CODE FOURNISSEUR	DESIGNATION		HT €
IM239254	UAS055B01A401NNN	SOUL_S BOOSTER 1216X550MM 505+1000W BLANC	NS	593,75
IM239255	UAM055B01A401NNN	SOUL_S BOOSTER 1580X550MM 655+1000W BLANC	NS	660,00
IM239256	UAE055B01A401NNN	SOUL_S BOOSTER 1888X550MM 825+1000W BLANC	NS	790,31

CHAUFFAGE

SECHE-SERVIETTES ...

- SECHE-SERVIETTES IRSAP KALIMBA CHAUFFAGE CENTRAL



H	L	Y	X
mm	mm	mm	mm
1189	500	212	765
1529	500	212	1105
1784	600	212	1360

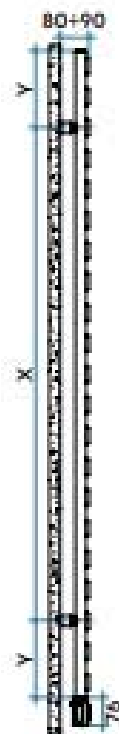
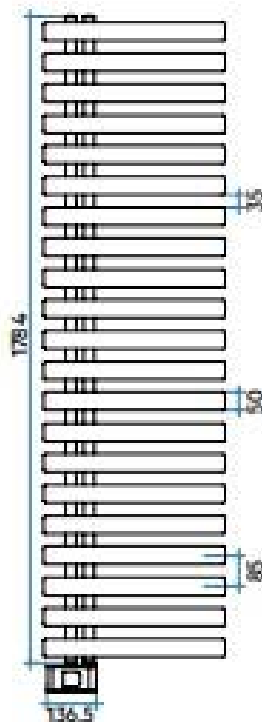
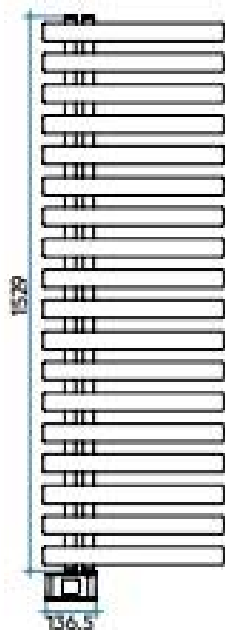
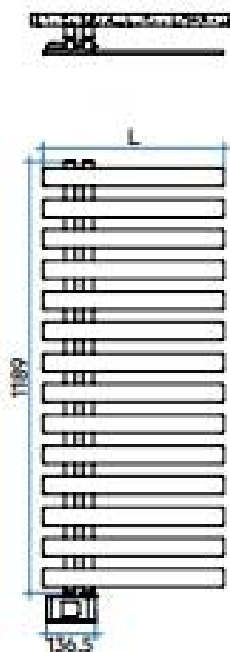

REFERENCE IMS	CODE FOURNISSEUR	DESIGNATION		HT €
IM074625	CHE050B01IR01NNN	KALIMBA - 1784X500MM - 704W - BLANC	NS	548,35
IM074614	CHM050B01IR01NNN	KALIMBA - 1189X500MM - 480W - BLANC	NS	361,66
IM074615	CHL060B01IR01NNN	KALIMBA - 1529X600MM - 687W - BLANC	NS	466,64
IM074616	CHE060B01IR01NNN	KALIMBA - 1784X600MM - 797W - BLANC	NS	577,42
IM074624	CHS050B01IR01NNN	KALIMBA - 849X500MM - 367W - BLANC	NS	303,33

CHAUFFAGE

SECHE-SERVIETTES ...

- SECHE-SERVIETTES ELECTRIQUE IRSAP JAZZ-S BOOSTER

Installation

H	Y	X
mm	mm	mm
880	500	340
1260	500	720
1460	600	920
1820	600	1280

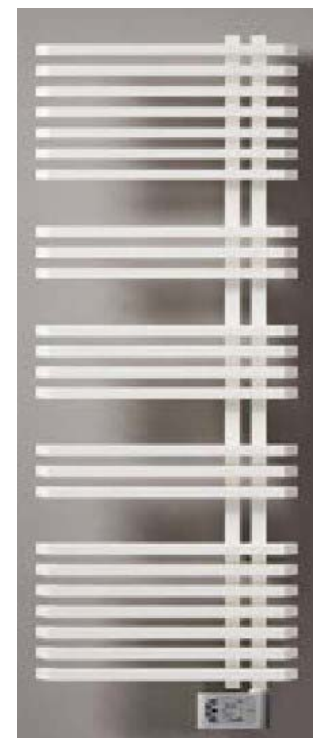
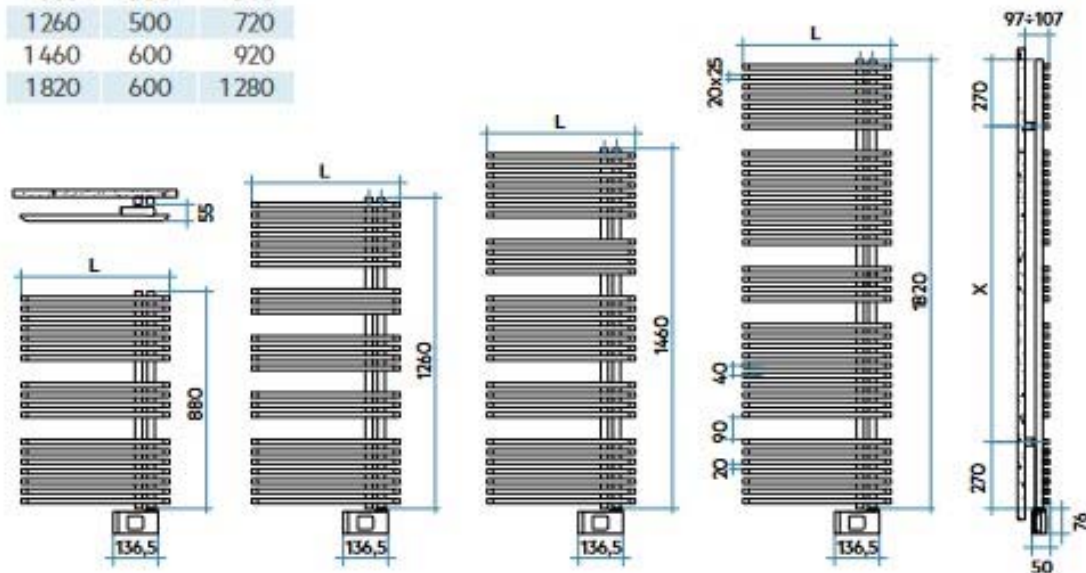

COLLECTEUR A DROITE

REFERENCE IMS	CODE FOURNISSEUR	DESIGNATION	HT €
IM239246	ZBL060B01A401NNN	JAZZ_S BOOSTER 1497X600MM 731+1000W BLANC	NS 875,63
IM239247	ZBG060B01A401NNN	JAZZ_S BOOSTER 1857X600MM 909+1000W BLANC	NS 1004,06

COLLECTEUR A GAUCHE

REFERENCE IMS	CODE FOURNISSEUR	DESIGNATION	HT €
IM239248	ZAL060B01A401NNN	JAZZ_S BOOSTER 1497X600MM 731+1000W BLANC	NS 875,63
IM239249	ZAG060B01A401NNN	JAZZ_S BOOSTER 1857X600MM 909+1000W BLANC	NS 1004,06

CHAUFFAGE

SECHE-SERVIETTES ...

- SECHE-SERVIETTES IRSAP JAZZ-S CHAUFFAGE CENTRAL

IRSAP
creating your comfort

Installation

H	L	X
mm	mm	mm
880	500	340
1260	500	720
1460	500	920
1460	600	920
1820	600	1280

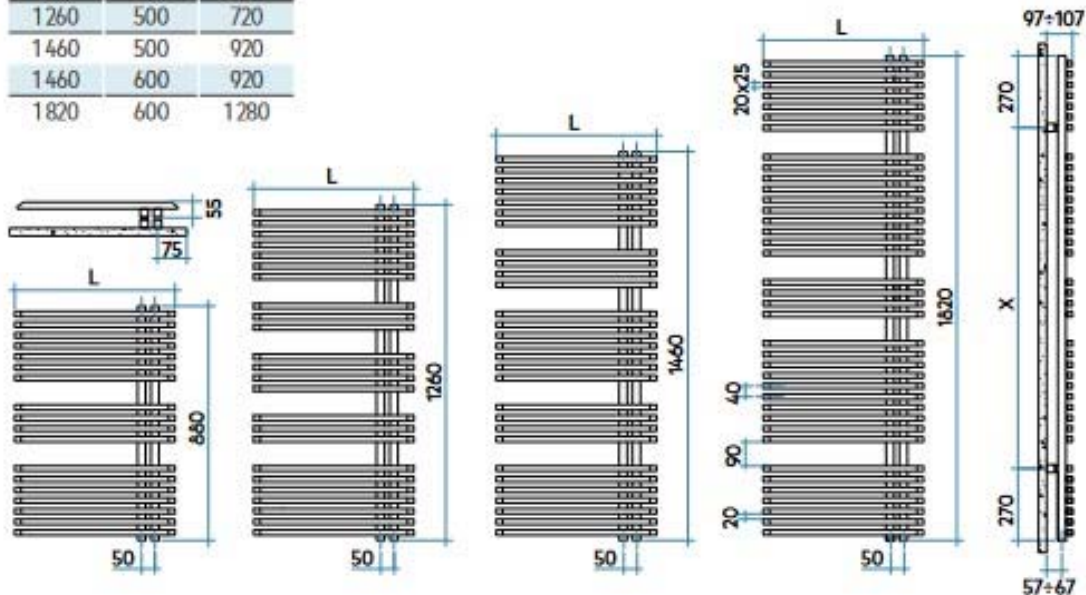

COLLECTEUR DROITE OU GAUCHE

REFERENCE IMS	CODE FOURNISSEUR	DESIGNATION	HT €
IM239241	ZRS050B01IR01NNN	JAZZ_S - 880X500MM - 415W - BLANC	NS 467,81
IM239242	ZRM050B01IR01NNN	JAZZ_S - 1260X500MM - 541W - BLANC	NS 524,06
IM239243	ZRL050B01IR01NNN	JAZZ_S - 1460X500MM - 637W - BLANC	NS 570,00
IM239244	ZRL060B01IR01NNN	JAZZ_S - 1460X600MM - 731W - BLANC	NS 618,75
IM239245	ZRG060B01IR01NNN	JAZZ_S - 1820X600MM - 909W - BLANC	NS 749,06

CHAUFFAGE

SECHE-SERVIETTES ...

- SECHE-SERVIETTES IRSAP FUNKY-S CHAUFFAGE CENTRAL

IRSAP
creating your comfort

Installation

H	L	X
mm	mm	mm
928	500	355
1170	500	597
1455	500	882
1455	600	882
1842	600	1269

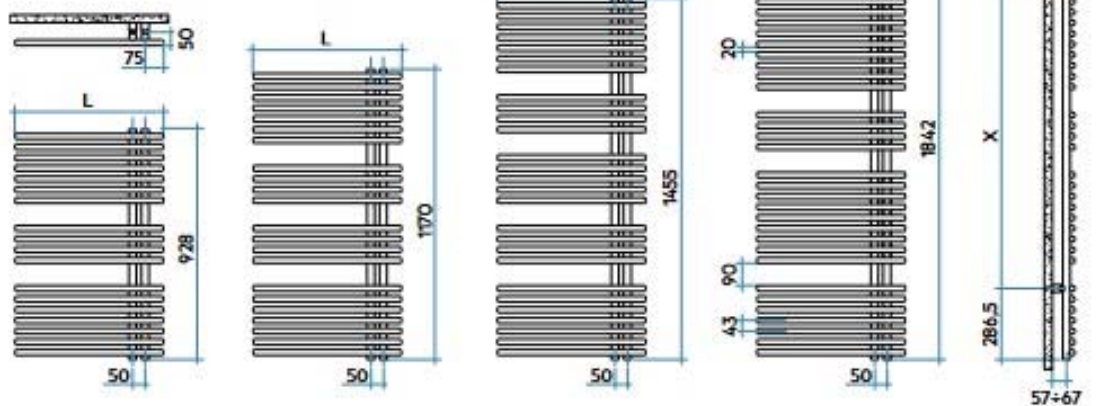

REFERENCE IMS	CODE FOURNISSEUR	DESIGNATION		HT €
IM239283	YRS050B01IR01NNN	FUNKY_S - 928X500MM - 402W - BLANC	NS	345,00
IM239284	YRM050B01IR01NNN	FUNKY_S - 1170X500MM - 488W - BLANC	NS	370,31
IM239285	YRL050B01IR01NNN	FUNKY_S - 1455X500MM - 592W - BLANC	NS	389,06
IM239286	YRL060B01IR01NNN	FUNKY_S - 1455X600MM - 688W - BLANC	NS	410,63
IM239287	YRG060B01IR01NNN	FUNKY_S - 1842X600MM - 891W - BLANC	NS	534,38

CHAUFFAGE

SECHE-SERVIETTES ...

- SECHE-SERVIETTES IRSAP FUNKY-S BOOSTER CHAUFFAGE C

IRSAP
creating your comfort

Installation

H	L	X
mm	mm	mm
1210	600	597
1495	600	882
1882	600	1269

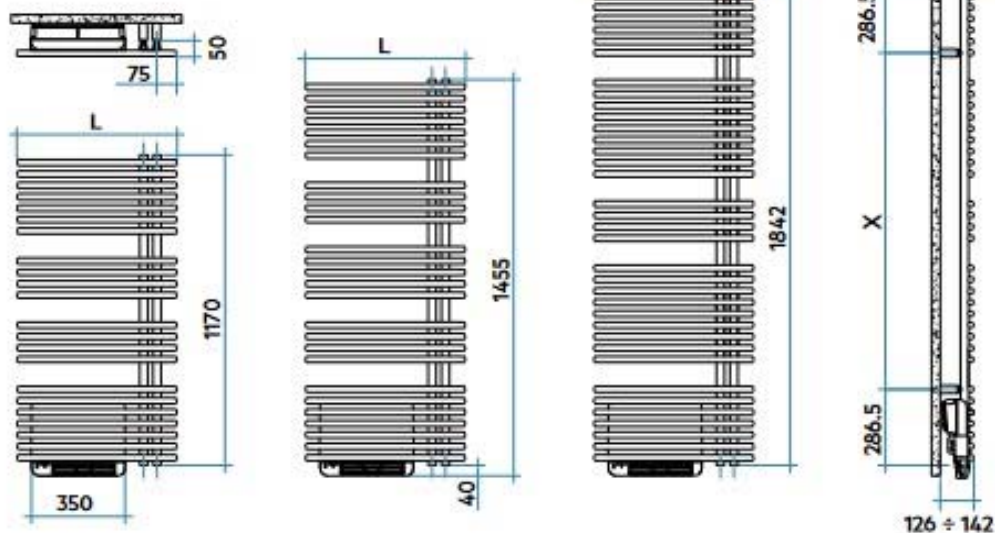

COLLECTEUR A DROITE

REFERENCE IMS	CODE FOURNISSEUR	DESIGNATION	HT €
IM239240	YBM060B01A401NNN	FUNKY_S BOOSTER 1210X600MM 572+1000W BLANC	NS 545,63
IM239288	YBL060B01A401NNN	FUNKY_S BOOSTER 1495X600MM 688+1000W BLANC	NS 645,00
IM239289	YBG060B01A401NNN	FUNKY_S BOOSTER 1882X600MM 891+1000W BLANC	NS 786,56

COLLECTEUR A GAUCHE

REFERENCE IMS	CODE FOURNISSEUR	DESIGNATION	HT €
IM239290	YAM060B01A401NNN	FUNKY_S BOOSTER 1210X600MM 572+1000W BLANC	NS 545,63
IM239291	YAL060B01A401NNN	FUNKY_S BOOSTER 1495X600MM 688+1000W BLANC	NS 645,00
IM239292	YAG060B01A401NNN	FUNKY_S BOOSTER 1882X600MM 891+1000W BLANC	NS 786,56

CHAUFFAGE

CHAUFFE-EAU ELECTRIQUE

● STEATITE ACI

DURALIS CONNECT



REFERENCE IMS	CODE FOURNISSEUR	DESIGNATION	HT €
IM242367	271093	CHAUFFE-EAU DURALIS CONNECT 150L VM	516,00
IM238346	271094	CHAUFFE-EAU DURALIS CONNECT VM 200L	582,96

● CHAUFFE-EAU PLAT



REFERENCE IMS	CODE FOURNISSEUR	DESIGNATION	HT €
IM239812	231081	MALICIO 3 MULTIPOSITION 100L BLC 2250	715,52

COLONNE DE DOUCHE THERMOSTATIQUE

● RAMON SOLER

Ramon Soler®
STOCK PLATEFORME 



REFERENCE IMS	CODE FOURNISSEUR	DESIGNATION	HT €
IM238758	94D308083	COLONNE DE DOUCHE THERMOSTATIQUE TELESCOPIQUE CHROME	363,46



REFERENCE IMS	CODE FOURNISSEUR	DESIGNATION	HT €
IM238757	94D308085	COLONNE DE DOUCHE THERMOSTATIQUE TELESCOPIQUE CHROME	223,51



REFERENCE IMS	CODE FOURNISSEUR	DESIGNATION	HT €
IM238756	94D308087	COLONNE DE DOUCHE THERMOSTATIQUE TELESCOPIQUE CHROME	294,50



REFERENCE IMS	CODE FOURNISSEUR	DESIGNATION	HT €
IM238755	94D306803	COLONNE DE DOUCHE THERMOSTATIQUE TELESCOPIQUE NOIR MAT	419,87

● RAMON SOLER

Ramon Soler®
STOCK PLATEFORME 



REFERENCE IMS	CODE FOURNISSEUR	DESIGNATION	HT €
IM238754	99H304959	ENSEMBLE BARRE DE DOUCHE NOIR MAT	269,69

SANITAIRE

PACK CUVETTE

- SANINDUSA

sanindusa®



REFERENCE IMS	CODE FOURNISSEUR	DESIGNATION	HT €
IM238240	140946004	PACK CUVETTE SUSP. RIMFLUSH URB.Y 52 BL	227,16
IM238237	140936004	PACK WC SUSPENDU URBY RIMFLUSH 48CM ABATTANT SLIM	227,16

PACK WC SOL

- PACK WC SOL SANINDUSA

sanindusa®



REFERENCE IMS	CODE FOURNISSEUR	DESIGNATION	HT €
IM236795	140918004	PACK WC AU SOL URBY RIMFLUSH	272,56

PACK WC SURELEVE

- PACK WC SURELE SANINDUSA

sanindusa®



REFERENCE IMS	CODE FOURNISSEUR	DESIGNATION	HT €
IM001352	130923004	PACK CUVETTE PROGET CONF S/V_E/L BL	304,92

ROBINET FLOTTEUR

- NICOLL-ORCAB

Nicoll
by allaxis
STOCK PLATEFORME 



REFERENCE IMS	CODE FOURNISSEUR	DESIGNATION	HT €
4070701052	0701052	ROBINET SILENCIEUX ALIM BASSE LAITON 3/8 SIL30	26,90

RAMON SOLER

Ramon Soler®
STOCK PLATEFORME 

- NEW FLY



REFERENCE IMS	CODE FOURNISSEUR	DESIGNATION	HT €
IM239377	94C307784	MITIGEUR THERMOSTATIQUE BAIN DOUCHE NOIR MAT	275,18

SANITAIRE

RAMON SOLER ...

- NEW FLY ...



REFERENCE IMS	CODE FOURNISSEUR	DESIGNATION	HT €
IM239376	94D308163	MITIGEUR THERMOSTATIQUE DOUCHE NOIR MAT	193,32



REFERENCE IMS	CODE FOURNISSEUR	DESIGNATION	HT €
IM238759	57A305996	MITIGEUR LAVABO NOIR MAT	89,23



REFERENCE IMS	CODE FOURNISSEUR	DESIGNATION	HT €
IM238760	57A306083	MITIGEUR LAVABO HAUT NOIR MAT	192,47

CUISINETTE

- CUISINETTE VITRO OU INDUCTION



REFERENCE IMS	CODE FOURNISSEUR	DESIGNATION	HT €
IM242244	MC10048501P2	MEUBLE CUISINETTE 100X60CM BLANC 1PTE	114,86



REFERENCE IMS	CODE FOURNISSEUR	DESIGNATION	HT €
IM242242	MC12048502P	MEUBLE CUISINETTE 120X60CM BLANC 2PTES	98,63



REFERENCE IMS	CODE FOURNISSEUR	DESIGNATION	HT €
IM242243	EV1000NU	EVIER CUISINETTE 100X60CM INOX	141,71
IM242241	EV1200NU	EVIER CUISINETTE 120X60CM INOX LISSE	150,50

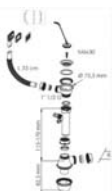

REFERENCE IMS	CODE FOURNISSEUR	DESIGNATION	HT €
IM201597	V1TPVC	VIDAGE MANUEL 1 CUVE BONDE 60 CHAINETTE	4,52



REFERENCE IMS	CODE FOURNISSEUR	DESIGNATION	HT €
IM242406	DEM29IN	DOMINO ELECTRIQUE MINUTEUR	117,00

CUISINETTE ...

- CUISINETTE VITRO OU INDUCTION ...



REFERENCE IMS	CODE FOURNISSEUR	DESIGNATION	HT €
IM242404	PI29	DOMINO INDUCTION NOIR EN VERRE	284,70



REFERENCE IMS	CODE FOURNISSEUR	DESIGNATION	HT €
IM242405	DVS2500	DOMINO VITRO TOUCHES SENSITIVES	177,45



REFERENCE IMS	CODE FOURNISSEUR	DESIGNATION	HT €
IM225107	ROTT92SF	REFRIGERATEUR TOP 90L(CL F)H83,1XL47,4XP44,7CM SILVER	157,50

ELECTRICITE

GAINES PREFILEES

● COURANT FORT



REFERENCE IMS	CODE FOURNISSEUR	DESIGNATION	HT €
PRE3X1,5ROO	F1U15AAR	GAINES PREFIL D16 3X1,5 RO-OR-OR	0,89

APPAREILLAGE LEGRAND

● CELIANE PLAQUE



BASALTE



REFERENCE IMS	CODE FOURNISSEUR	DESIGNATION	HT €
735066741	066741	PLAQUE 1P BASALTE	6,47
735066742	066742	PLAQUE 2P BASALTE	12,92

NOIR



REFERENCE IMS	CODE FOURNISSEUR	DESIGNATION	HT €
IM210425	066681	PLAQUE 1P NOIR	2,34
IM053395	066682	PLAQUE 2P NOIR	4,69
IM072193	066683	PLAQUE 3P NOIR	7,03

TUNGSTENE



REFERENCE IMS	CODE FOURNISSEUR	DESIGNATION	HT €
735068971	068971	PLAQUE METAL 1P TUNGSTENE	11,98
735068972	068972	PLAQUE METAL 2P TUNGSTENE	23,97

ECLAIRAGE INTERIEUR

● SPOT RECOUVRABLE



REFERENCE IMS	CODE FOURNISSEUR	DESIGNATION	HT €
IM239620	0005363	OBICO IP65 550 3T DIM BLANC	40,96

● SPOT EN APPLIQUE



REFERENCE IMS	CODE FOURNISSEUR	DESIGNATION	HT €
717132021	132021	SPOT 79 230V APPLIQUE ET PLAFONNIER, BLANC, GU10, MAX. 50W	30,70



REFERENCE IMS	CODE FOURNISSEUR	DESIGNATION	HT €
717132020	132020	SPOT 79 GU10, NOIR, AVEC PATERE 230V	30,70

ELECTRICITE

ECLAIRAGE EXTERIEUR



REFERENCE IMS	CODE FOURNISSEUR	DESIGNATION	HT €
IM240556	1006184	GRAFIT 90 CARRE E27 11W MAX	122,81

● APPLIQUE EXTERIEURE



REFERENCE IMS	CODE FOURNISSEUR	DESIGNATION	HT €
IM019177	230657	MERIDIAN BOX 2 APPLIQUE FONTE ROUILLEE	98,00

DOMOTIQUE

● DELTA DORE



REFERENCE IMS	CODE FOURNISSEUR	DESIGNATION	HT €
IM231207	6702000	TYWELL PRO	218,44

PILE ET BATTERIE

● PILE



REFERENCE IMS	CODE FOURNISSEUR	DESIGNATION	HT €
IM239004	06205_301_401	PILE LITHIUM CR123A X1	5,21



REFERENCE IMS	CODE FOURNISSEUR	DESIGNATION	HT €
IM239005	06122_301_401	PILE LITHIUM 6LR61 X1	17,52

FOURNITURES GENERALES

ETANCHEITE

- MASTIC SILICONE A BASE AQUEUSE POUR SURFACE



REFERENCE IMS	CODE FOURNISSEUR	DESIGNATION	HT €
IM229618	106960	REPARATEUR EMAIL 2 TUBES 20 G / BLISTER	13,82

GRAISSE ET LUBRIFIANT



REFERENCE IMS	CODE FOURNISSEUR	DESIGNATION	HT €
IM238400	OR00595909	DEGRIPPANT LUBRIFIANT WD40 AEROSOL 500ML	11,74

PLOMBERIE - RACCORD

- PVC EVACUATION GRIS



- TUBE SOUPLE



REFERENCE IMS	CODE FOURNISSEUR	DESIGNATION	HT €
IM236291	TUFLEX32N	D32 L.1M.	6,43
IM236290	TUFLEX40N	D40 L.1M.	6,73
IM236292	TUFLEX50N	D50 L.1M.	12,73

MANCHON ISOLANT

- ADHESIF A RECOUVREMENT (2ML)



REFERENCE IMS	CODE FOURNISSEUR	DESIGNATION	HT €
IM227926	ST19X032R	19MM D32	3,31
IM184587	ST19X022R	19MM D22	2,39
IM240418	ST25X032R	25MM D32	5,38

CARRELAGE

ECOULEMENT

- CANIVEAU DE DOUCHE



REFERENCE IMS	CODE FOURNISSEUR	DESIGNATION	HT €
IM238564	13050200	CANIVEAU LINEARIS COMPACT L750 MM	318,12
IM238565	13050201	CANIVEAU LINEARIS COMPACT L850MM	321,96
IM238566	13050202	CANIVEAU LINEARIS COMPACT L950MM	325,81

PROFILE

- CHANT DROIT



REFERENCE IMS	CODE FOURNISSEUR	DESIGNATION	HT €
IM238744	PT125-01	PROFILE CHANT DROIT PVC BLANC EP 12,5MM L.2,7ML	3,71

NATTE



REFERENCE IMS	CODE FOURNISSEUR	DESIGNATION	HT €
IM242352	FIXOSUP 20KG	FIXOSUP 20KG COL NATTE DESOLIDARISATION	151,14
IM242351	FIXOSUP 5KG	FIXOSUP 5KG COLLE NATTE DESOLIDARISATION	59,90



REFERENCE IMS	CODE FOURNISSEUR	DESIGNATION	HT €
IM242350	NATTEDESOLIDARI	NATTE DESOLIDARISATION 1MX20ML	156,31

CONSOMMABLE



REFERENCE IMS	CODE FOURNISSEUR	DESIGNATION	HT €
IM230671	MN1601	NIVELEUR REUTILISABLE POUR CARREAU DE 2 A 12MM	62,80



REFERENCE IMS	CODE FOURNISSEUR	DESIGNATION	HT €
IM230672	MG160A1	NIVELEUR REUTILISABLE POUR CARREAU DE 12 A 20 MM	62,80



REFERENCE IMS	CODE FOURNISSEUR	DESIGNATION	HT €
IM230673	061484	RONDELLE DE PROTECTION POUR SOL DELICATS RONDELLA75	11,96



REFERENCE IMS	CODE FOURNISSEUR	DESIGNATION	HT €
IM230675	BRU161A	CROISILLONS POUR JOINT DE 1MM A 20MMMM	19,94

CARRELAGE

CONSOMMABLE ...



REFERENCE IMS	CODE FOURNISSEUR	DESIGNATION	HT €
IM230674	BRU161	CROISILLONS POUR JOINT DE 1,6MM A 20MM	14,95



REFERENCE IMS	CODE FOURNISSEUR	DESIGNATION	HT €
IM230676	STANDARD2	CROISILLONS POUR JOINT DE 2MM A 20MMMM	14,95

● ACCESSOIRE DE POSE



REFERENCE IMS	CODE FOURNISSEUR	DESIGNATION	HT €
IM238839	18919	VENTOUSE POMPE A VIDE Ø 200	92,87



REFERENCE IMS	CODE FOURNISSEUR	DESIGNATION	HT €
IM197478	400465	CORDEAU CORDEX PRO ROUGE FIL 1MM TRESSE	NS 18,11

● COUPE - MOLETTE - DISQUE



REFERENCE IMS	CODE FOURNISSEUR	DESIGNATION	HT €
IM060846	17915	COUPE-CARREAUX TX-1020 MAX	773,77

NETTOYAGE ET PROTECTION



REFERENCE IMS	CODE FOURNISSEUR	DESIGNATION	HT €
IM242187	60410012FRA	DETERDEK PRO FILA 1L	11,36



REFERENCE IMS	CODE FOURNISSEUR	DESIGNATION	HT €
IM242176	60510012FRA	CLEANER PRO FILA 1L	12,26

CARRELAGE

NETTOYAGE ET PROTECTION ...



REFERENCE IMS	CODE FOURNISSEUR	DESIGNATION	HT €
IM055203	53000012FRA	FILA PS 87 1 LT FILA DETERGENT DEGRAISSANT	22,50



REFERENCE IMS	CODE FOURNISSEUR	DESIGNATION	HT €
IM055204	53001012FRA	FILACR 10 1 LT FILA NETTOYANT RESIDUS EPOXY	27,00



REFERENCE IMS	CODE FOURNISSEUR	DESIGNATION	HT €
IM242349	61500006FRA	HYDROFUGE MP90 ECO XTREME	68,18



REFERENCE IMS	CODE FOURNISSEUR	DESIGNATION	HT €
IM229547	390605	SAC A GRAVATS 70 LITRES POLYPRO BLANC 55	1,53

CARREAU DE SOL INTERIEUR IMITATION BOIS

- 20X120



REFERENCE IMS	CODE FOURNISSEUR	DESIGNATION	HT €
IM234331	8435592039473	CX 20X120 BONNET LIGHT XS RECT	30,00



REFERENCE IMS	CODE FOURNISSEUR	DESIGNATION	HT €
IM238121	8435592047188	PLINTHE 9X120 BONNET LIGHT	15,56



REFERENCE IMS	CODE FOURNISSEUR	DESIGNATION	HT €
IM016653	M0DT	CX 20X120 TREVERKVIEW MIELE RECTIFIE	40,60



REFERENCE IMS	CODE FOURNISSEUR	DESIGNATION	HT €
IM016665	M0HH	PLINTHE 6X60 TREVERKVIEW MIELE	9,90

SOMMAIRE SUPPRESSIONS PRODUITS OCTOBRE 2023

■ CHAUFFAGE

page 31

● GAZ MURAL CONDENSATION ATLANTIC.....	page 31
● REGULATION VAILLANT.....	page 31
● CHAUDIERE FIOUL ATLANTIC.....	page 31
● CHAUDIERE FIOUL OERTLI.....	page 31
● CHAUDIERE FIOUL CONDENS VAILLANT.....	page 32
● AEROTHERMIE DAIKIN BASSE TEMPERATURE.....	page 32
● AEROTHERMIE OERTLI FIRST (CHAUFFAGE SEUL).....	page 32
● AEROTHERMIE OERTLI SLIM (CHAUFFAGE+ECS).....	page 33
● AEROTHERMIE OERTLI COLONNE (CHAUFFAGE+ECS).....	page 34
● AEROTHERMIE OERTLI CONFORT (CHAUFFAGE+ECS).....	page 34
● DESEMBOUANT.....	page 35
● OERTLI.....	page 35
● DOMESTIQUE.....	page 36
● ACCESSOIRE.....	page 36
● THERMOSTAT.....	page 36
● CONDUIT PELLETT EMAIL NOIR MAT DIAMETRE 80MM.....	page 36
● APPAREIL DE MESURE.....	page 37
● PRODUIT ENTRETIEN.....	page 38
● RAMONAGE CONDUIT.....	page 38
● PRODUIT ENTRETIEN CIRCUIT CHAUFFAGE.....	page 38
● PIECE DETACHEE POUR BRULEUR.....	page 38
● ISOLANT DE SOL.....	page 39
● COLLECTEUR.....	page 39
● RADIATEUR ACOVA VERTICAL.....	page 39
● ROBINETTERIE RBM.....	page 40
● RACCORDEMENT RADIATEUR ROBINETTERIE INTEGREE.....	page 40
● CHAUFFE-EAU ELECTRIQUE.....	page 40
● CHAUFFE-EAU ECHANGEUR (PREPARATEUR ECS).....	page 40
● ACCESSOIRE POUR CHAUFFE-EAU.....	page 41
● GROUPE DE SECURITE.....	page 41
● PIECE DE RECHANGE.....	page 41
● THERMOR AEROMAX.....	page 42
● PROPANE.....	page 42
● STATION SOLAIRE.....	page 42
● PREPARATEUR ECS.....	page 42
● LIAISON SOLAIRE.....	page 43
● ACCESSOIRE SOLAIRE.....	page 43

■ CLIMATISATION

page 44

● MONOSPLIT MURAL ATLANTIC.....	page 44
● ACCESSOIRE.....	page 44

■ VENTILATION

page 45

● PAVILLONNAIRE.....	page 45
----------------------	---------

SOMMAIRE SUPPRESSIONS PRODUITS OCTOBRE 2023

SANITAIRE

page 46

● RECEVEUR	page 46
● NOVELLINI GAMME SAMBA CADREE HT 1850MM VERRE 3MM	page 46
● COLONNE DE DOUCHE THERMOSTATIQUE	page 46
● ACCESSOIRE ENCASTREMENT	page 46
● BARRE DE DOUCHE	page 46
● GARNITURE DOUCHE BAIGNOIRE	page 47
● DOUCHETTE	page 47
● ENSEMBLE DE DOUCHE	page 47
● SUPPORT MURAL	page 48
● CUVETTE	page 48
● PACK CUVETTE	page 48
● CUVETTE	page 48
● ABATTANT	page 49
● RESERVOIR ACRYLIQUE	page 49
● ROBINET FLOTTEUR	page 49
● FIXATION	page 49
● DE FACE - CERAMIQUE	page 50
● MEUBLE LAVE-MAINS	page 50
● MUNDO	page 50
● COCOON	page 51
● CARLO FRATTINI	page 51
● GROHE	page 51
● FRANKE	page 53
● AKW	page 53
● EVIER A ENCASTRER INOX	page 53
● EVIER A ENCASTRER SYNTHESE FRANKE	page 53
● CUISINETTE	page 54
● CUVE SOUS PLAN SYNTHESE	page 54
● CUVE SOUS PLAN INOX	page 55
● TEMPORISE	page 55
● DOUCHE	page 55
● EVIER	page 55
● POMME DE DOUCHE	page 55

ELECTRICITE

page 56

● FIL RIGIDE	page 56
● GAINÉ PREFILEE	page 56
● COFFRET RESI9	page 56
● COFFRET DE DISTRIBUTION ABB	page 56
● COFFRET ETANCHE / ARMOIRE DE DISTRIBUTION 250A	page 57
● DISJONCTEUR ABB	page 58
● DISJONCTEUR MOTEUR	page 58
● APPAREILLAGE SCHNEIDER	page 58
● APPAREILLAGE HAGER	page 61
● SOURCE	page 62
● ECLAIRAGE INTERIEUR	page 63
● ECLAIRAGE EXTERIEUR	page 64
● ECLAIRAGE FONCTIONNEL	page 65
● COMMANDE D'ECLAIRAGE	page 65
● RADIATEUR THERMOR	page 66
● RADIATEUR ACOVA	page 68
● DOMOTIQUE	page 68
● DOMOTIQUE YOKIS	page 68
● COFFRET DE COM	page 69
● BOITE DE MACONNERIE SCHNEIDER	page 70
● BOITE D'ENCASTREMENT SCHNEIDER	page 70
● MAISON NEUVE KIT AUTOCONSOMMATION	page 71
● IDEAL RENOVATION	page 71

ADDITION D'EAU

page 72

● ACCESSOIRE	page 72
● MASSAL	page 72

SOMMAIRE SUPPRESSIONS PRODUITS OCTOBRE 2023

■ FOURNITURES GENERALES

page 73

● ANTI-BELIER	page 73
● ROBINET D'ARRET	page 73
● CUIVRE A SERTIR EAU	page 73
● CUIVRE A SERTIR GAZ	page 73
● MULTICOUCHE UPONOR	page 73
● FONTE GALVA	page 73
● FONTE NOIRE	page 74
● RACCORD A COMPRESSION PLASTIQUE	page 75
● RACCORD RAPIDE (TYPE TECTITE)	page 76
● PVC EVACUATION GRIS	page 76
● PVC PRESSION	page 77
● COLLECTEUR SANITAIRE	page 77
● ACIER	page 77
● PRODUIT DE SCELLEMENT	page 77
● JOINT	page 77
● PEINTURE ET TRACAGE	page 78
● CHEVILLE	page 78
● FIXATION SANITAIRE	page 78
● VISSERIE ET BOULONNERIE	page 78

■ OUTILLAGE

page 80

● MILWAUKEE	page 80
● ABRASIF ET DISQUE	page 80
● FORET BETON (MARTEAU) SDS	page 80
● ACCESSOIRE GOP (MULTIFONCTION)	page 80
● OUTILLAGE	page 81
● OUTILLAGE ELECTRICIEN	page 82
● PROTECTION HYGIENE	page 82
● ENTRETIEN DES SURFACES	page 82

■ CARRELAGE

page 83

● PRODUIT DE MISE EN OEUVRE	page 83
● PROFILE	page 83
● NATTE	page 83
● CONSOMMABLE	page 83
● NETTOYAGE ET PROTECTION	page 84
● CARREAU DE SOL INTERIEUR - IMITATION BOIS	page 84

CHAUFFAGE

GAZ MURAL CONDENSATION

- NAEMA 2 CHAUFFAGE+ECS ACCUMULEE



REFERENCE IMS	CODE FOURNISSEUR	DESIGNATION	HT €
A05A00034	074222	BARETTE ROBINETS NAEMA DUO 25/35	NS 220,00

- REGULATION



REFERENCE IMS	CODE FOURNISSEUR	DESIGNATION	HT €
A05A00043	072121	THERMOSTAT AMBIANCE SIMPLE FILAIRE	NS 36,10

REGULATION VAILLANT



REFERENCE IMS	CODE FOURNISSEUR	DESIGNATION	HT €
4770020018265	0020018265	CALORMATIC VRT 50	NS 104,26

CHAUDIERE FIOUL

- AXEO NOX CONDENS DUO CHAUFFAGE + ECS

Ballon 120L acier émaillé avec ACI

Régulation Nvaistem 200S sur température extérieure de série gestion 2 zones



REFERENCE IMS	CODE FOURNISSEUR	DESIGNATION	HT €
IM016918	026658	CHAUDIERE FIOUL CONDENS AXEO NOX DUO 25 26kw débit 21L/min	NS 6677,30

CHAUDIERE FIOUL OERTLI

- CHAUDIERE FIOUL CONDENSATION



REFERENCE IMS	CODE FOURNISSEUR	DESIGNATION	HT €
IM073147	7736424	CHAUDIERE FIOUL CONDENS OERTLI OFSC 24	NS 5307,30



REFERENCE IMS	CODE FOURNISSEUR	DESIGNATION	HT €
IM073148	7744614	KIT DE RACCORDEMENT CHAUDIERE-BALLON	NS 355,20

CHAUFFAGE

CHAUDIERE FIOUL CONDENS VAILLANT

- VAILLANT CHAUFFAGE SEUL



REFERENCE IMS	CODE FOURNISSEUR	DESIGNATION		HT €
4770010010677	0010010677	Chaudière sol fioul à condensation, chauffage seul icoVIT 24KW	NS	6952,00
4770010010679	0010010679	Chaudière sol fioul à condensation, chauffage seul icoVIT 34KW	NS	8275,00

AEROTHERMIE DAIKIN BASSE TEMPERATURE

- GROUPE EXTERIEUR PAS R32



REFERENCE IMS	CODE FOURNISSEUR	DESIGNATION		HT €
IM014263	ERGA04DV	GROUPE EXTERIEUR MONOPHASE R32 TAILLE 4KW	NS	2165,04
IM021628	ERGA08DV	GROUPE EXTERIEUR MONOPHASE R32 TAILLE 8KW	NS	3602,06

AEROTHERMIE OERTLI FIRST (CHAUFFAGE SEUL)

- PAC 11KW APPOINT ELEC.TRIPHASE



REFERENCE IMS	CODE FOURNISSEUR	DESIGNATION		HT €
IM010011	7609928	UNITE EXTERIEUR OERTLI OENOVIPAC 11KW TRIPHASE	NS	4527,78

- PAC 16KW APPOINT ELEC.MONO



REFERENCE IMS	CODE FOURNISSEUR	DESIGNATION		HT €
IM059233	7609929	UNITE EXTERIEUR OERTLI OENOVIPAC 16KW MONOPHASE	NS	5313,15

- PAC 16KW APPOINT ELEC



REFERENCE IMS	CODE FOURNISSEUR	DESIGNATION		HT €
IM059234	7609930	UNITE EXTERIEUR OERTLI OENOVIPAC 16KW TRIPHASE	NS	5746,43

CHAUFFAGE

AEROTHERMIE OERTLI SLIM (CHAUFFAGE+ECS)

● PAC 11KW APPOINT ELEC.TRIPHASE



REFERENCE IMS	CODE FOURNISSEUR	DESIGNATION		HT €
IM010011	7609928	UNITE EXTERIEUR OERTLI OENOVIPAC 11KW TRIPHASE	NS	4527,78
IM018557	7666419	BALLON 180 HPSL POUR PAC OENOVIPAC SLIM OERTLI	NS	1115,37
IM018558	7670250	KIT HYDRAULIQUE OERTLI OENOVIA PAC SLIM	NS	671,49

● PAC 16KW APPOINT ELEC.MONO



REFERENCE IMS	CODE FOURNISSEUR	DESIGNATION		HT €
IM059233	7609929	UNITE EXTERIEUR OERTLI OENOVIPAC 16KW MONOPHASE	NS	5313,15
IM018557	7666419	BALLON 180 HPSL POUR PAC OENOVIPAC SLIM OERTLI	NS	1115,37
IM018558	7670250	KIT HYDRAULIQUE OERTLI OENOVIA PAC SLIM	NS	671,49

● PAC 16KW APPOINT ELEC.TRIPHASE



REFERENCE IMS	CODE FOURNISSEUR	DESIGNATION		HT €
IM059234	7609930	UNITE EXTERIEUR OERTLI OENOVIPAC 16KW TRIPHASE	NS	5746,43
IM018557	7666419	BALLON 180 HPSL POUR PAC OENOVIPAC SLIM OERTLI	NS	1115,37
IM018558	7670250	KIT HYDRAULIQUE OERTLI OENOVIA PAC SLIM	NS	671,49

CHAUFFAGE

AEROTHERMIE OERTLI COLONNE (CHAUFFAGE+ECS)

● PAC 11KW APPOINT ELEC.TRIPHASE



REFERENCE IMS	CODE FOURNISSEUR	DESIGNATION		HT €
IM010011	7609928	UNITE EXTERIEUR OERTLI OENOVIPAC 11KW TRIPHASE	NS	4527,78

● PAC 16KW APPOINT ELEC.MONO



REFERENCE IMS	CODE FOURNISSEUR	DESIGNATION		HT €
IM059233	7609929	UNITE EXTERIEUR OERTLI OENOVIPAC 16KW MONOPHASE	NS	5313,15

● PAC 16KW APPOINT



REFERENCE IMS	CODE FOURNISSEUR	DESIGNATION		HT €
IM059234	7609930	UNITE EXTERIEUR OERTLI OENOVIPAC 16KW TRIPHASE	NS	5746,43

AEROTHERMIE OERTLI CONFORT (CHAUFFAGE+ECS)

● PAC 4.5KW APPOINT



REFERENCE IMS	CODE FOURNISSEUR	DESIGNATION		HT €
IM010553	7609942	UNITE INTERIEUR OERTLI OENOVIPAC CONFORT 4.5/6/8 KW MONOPHASE	NS	2704,43

● PAC 11KW APPOINT ELEC TRI



REFERENCE IMS	CODE FOURNISSEUR	DESIGNATION		HT €
IM010011	7609928	UNITE EXTERIEUR OERTLI OENOVIPAC 11KW TRIPHASE	NS	4527,78
IM059196	7609943	UNITE INTERIEUR OERTLI OENOVIPAC CONFORT 11/16KW MONO ET TRIPHASE	NS	3014,94

● PAC 16KW APPOINT ELEC MONO



REFERENCE IMS	CODE FOURNISSEUR	DESIGNATION		HT €
IM059233	7609929	UNITE EXTERIEUR OERTLI OENOVIPAC 16KW MONOPHASE	NS	5313,15
IM059196	7609943	UNITE INTERIEUR OERTLI OENOVIPAC CONFORT 11/16KW MONO ET TRIPHASE	NS	3014,94

CHAUFFAGE

AEROTHERMIE OERTLI CONFORT (CHAUFFAGE+ECS) ...

● PAC 16KW APPOINT ELEC



REFERENCE IMS	CODE FOURNISSEUR	DESIGNATION		HT €
IM059234	7609930	UNITE EXTERIEUR OERTLI OENOVIPAC 16KW TRIPHASE	NS	5746,43
IM059196	7609943	UNITE INTERIEUR OERTLI OENOVIPAC CONFORT 11/16KW MONO ET TRIPHASE	NS	3014,94

● PAC 22KW APPOINT ELEC



REFERENCE IMS	CODE FOURNISSEUR	DESIGNATION		HT €
IM057863	7655104	UNITE EXT OERTLI OENOVIPAC CONFORT 22KW TRIPHASE	NS	5981,69

● PAC 27KW APPOINT ELEC



REFERENCE IMS	CODE FOURNISSEUR	DESIGNATION		HT €
IM059195	7655105	UNITE EXT OERTLI OENOVIPAC CONFORT 27KW TRIPHASE	NS	7134,93
IM057868	7609945	UNITE INTERIEUR OERTLI OENOVIPAC CONFORT 22/27KW TRIPHASE	NS	3997,43

DESEMBOUANT



REFERENCE IMS	CODE FOURNISSEUR	DESIGNATION		HT €
IM167041	DEP-4X5L-FR	NETTOYANT DEPOSIT REMOVER BIDON 5L	NS	121,31

OERTLI



● BRULEUR FIOUL



REFERENCE IMS	CODE FOURNISSEUR	DESIGNATION		HT €
IM070295	7724966	BRULEUR FIOUL OES 4 LE OERTLI 17 A 49 KW	NS	577,80

CHAUFFAGE

DOMESTIQUE

● CHAUFFAGE FRANCO



REFERENCE IMS	CODE FOURNISSEUR	DESIGNATION	HT €
421109922	109922	CIRCULATEUR MYL 30-20 RU 33X42	NS 209,83

● CHAUFFAGE WILO STRATOS PICO



REFERENCE IMS	CODE FOURNISSEUR	DESIGNATION	HT €
IM023266	4216616	STRATOS-PICO-25/1-4-130MM (ROW) G11/2	NS 221,36

ACCESSOIRE

● BRIDE



REFERENCE IMS	CODE FOURNISSEUR	DESIGNATION	HT €
469ZCB26	ZCB26	CONTRE BRIDES OVALE + BOULON FEM 1"	NS 32,74

THERMOSTAT

● THEBEN



REFERENCE IMS	CODE FOURNISSEUR	DESIGNATION	HT €
7668120132	8120132	THERMOSTAT PROGRAMMABLE JOURN/HEBDO ALIM. 230V	NS 127,52



REFERENCE IMS	CODE FOURNISSEUR	DESIGNATION	HT €
7668339501	8339501	THERMOSTAT PROG HEBDO DIGITAL RADIO 1ZONE PILE ET RECEPTEUR HF	NS 243,50

CONDUIT PELLETT EMAIL NOIR MAT DIAMETRE 80MM



● RACCORD INOX POELE-TUBAGE



REFERENCE IMS	CODE FOURNISSEUR	DESIGNATION	HT €
A55T00052	123805	RACCORD INOX POELE-TUBAGE 80M-155/161	NS 51,57

CHAUFFAGE

APPAREIL DE MESURE

● KANE



REFERENCE IMS	CODE FOURNISSEUR	DESIGNATION		HT €
IM017322	KANE458KITPRO	ANALYSEUR COMBUSTION, CELLULE 5 ANS (CO A DILUTION)+SONDE CP30+SAC	NS	1095,00

● KIMO



Analyseur de combustion KIGAZ 110



REFERENCE IMS	CODE FOURNISSEUR	DESIGNATION		HT €
IM017073	kigaz110	ANALYSEUR COMB PR TS TYPES DE CHAUDIERES AVEC 2 CELLS INTERCHANG	NS	1077,00



REFERENCE IMS	CODE FOURNISSEUR	DESIGNATION		HT €
IM018061	kigaz110g5	ANALYSEUR COMB TYPE KIGAZ 110 "GARANTIE 5 ANS" POUR TTE CHAUDIERE	NS	1571,00



REFERENCE IMS	CODE FOURNISSEUR	DESIGNATION		HT €
IM014189	kigaz210sg5	ANALYSEUR COMB TYPE KIGAZ 210S "GARANTIE 5 ANS" POUR TTS CHAUDIERE	NS	2065,00



REFERENCE IMS	CODE FOURNISSEUR	DESIGNATION		HT €
1544210	4210	OPACIMETRE COMPLET	NS	95,00

● CONSOMMABLE



REFERENCE IMS	CODE FOURNISSEUR	DESIGNATION		HT €
IM018510	KMCP30	SONDE DE COMBUSTION DOUBLE CANAL	NS	125,00

CHAUFFAGE

PRODUIT ENTRETIEN

- PROGALVA



REFERENCE IMS	CODE FOURNISSEUR	DESIGNATION		HT €
K40P00055	6011	MASQUE ANTI POUSSIERE SOUPEPE 6011	NS	4,64

RAMONAGE CONDUIT

- CANNE-HERISSON ET ACCESSOIRE



REFERENCE IMS	CODE FOURNISSEUR	DESIGNATION		HT €
IM009105	2095NM	FLEXONET LONG 15ML D7MM	NS	290,35



REFERENCE IMS	CODE FOURNISSEUR	DESIGNATION		HT €
4271694	1694	HERISSON PVC ROND D125MM	NS	22,59

PRODUIT ENTRETIEN CIRCUIT CHAUFFAGE

- PROTECTION X100



REFERENCE IMS	CODE FOURNISSEUR	DESIGNATION		HT €
446X1001C	X1001C	INHIBITEUR CORROSION X100 CONCENTRE EN CARTOUCHE POUR PISTOLET	NS	52,08

PIECE DETACHEE POUR BRULEUR

- POMPE FIOUL



REFERENCE IMS	CODE FOURNISSEUR	DESIGNATION		HT €
459514941	SRN514941	BOITE RELAIS TF 834-04	NS	269,66
459523813	SRN523813	BOITE RELAIS TF 844	NS	202,77

CHAUFFAGE

PIECE DETACHEE POUR BRULEUR ...

- AUTRE



REFERENCE IMS	CODE FOURNISSEUR	DESIGNATION	HT €
421142826	142826	ACCOUPEMENT BRULEUR STELLA 11/14/18/175/290/410	NS 6,69

ISOLANT DE SOL



- PLAQUE SOPREMA EFISOL (PRIX AU M²)



REFERENCE IMS	CODE FOURNISSEUR	DESIGNATION	HT €
723076793	76793	PLAQUE SOPREMA TMS EP30MM R=1,3 1X1,2M paquet de 12 = 14.4m2	13,88
723077959	77959	PLAQUE SOPREMA TMS EP48MM R=2,2 1X1,2M paquet de 8 = 9.6m2	NS 20,33
723078100	78100	PLAQUE SOPREMA TMS EP56MM R2,6 1X1,2M paquet de 7 = 8.4m2	22,80
723077960	77960	PLAQUE SOPREMA TMS EP80MM R=3,7 1X1,2M paquet de 5 = 6m2	32,43
723078109	78109	PLAQUE SOPREMA TMS EP100MM R=4,65 1X1,2M paquet de 4 = 4.8m2	38,75

COLLECTEUR

- INOX CAPRICORN AVEC DEBIMETRE



REFERENCE IMS	CODE FOURNISSEUR	DESIGNATION	HT €
IM010243	9-3950-002-96-2412OR1	COLLECTEUR PLANCHER INOX 2 CIRCUITS + DEBIMETRE	NS 124,61
IM010246	9-3950-005-96-2412OR1	COLLECTEUR PLANCHER INOX 5 CIRCUITS + DEBIMETRE	NS 151,49
IM010247	9-3950-006-96-2412OR1	COLLECTEUR PLANCHER INOX 6 CIRCUITS + DEBIMETRE	NS 162,38
IM010248	9-3950-007-96-2412OR1	COLLECTEUR PLANCHER INOX 7 CIRCUITS + DEBIMETRE	NS 174,98
IM010249	9-3950-008-96-2412OR1	COLLECTEUR PLANCHER INOX 8 CIRCUITS + DEBIMETRE	NS 185,36
IM010251	9-3950-010-96-2412OR1	COLLECTEUR PLANCHER INOX 10 CIRCUITS + DEBIMETRE	NS 220,75

- INOX HEIMEIER-IMI AVEC DEBIMETRE



REFERENCE IMS	CODE FOURNISSEUR	DESIGNATION	HT €
A40T00010	1837-00.500	TETE MOTORISEE 220V POUR DYNACON	NS 45,21

RADIATEUR ACOVA

- SECHE-SERVIETTES FASSANE EAU CHAUDE



REFERENCE IMS	CODE FOURNISSEUR	DESIGNATION	HT €
300857231	857231	KIT TH+RESIST BLANC ATOLL CALA ESCA 900W	NS 251,67

CHAUFFAGE

ROBINETTERIE RBM

- TE DE REGLAGE



REFERENCE IMS	CODE FOURNISSEUR	DESIGNATION		HT €
IM073225	1540400	TE DE REGLAGE 1/2	NS	7,44

RACCORDEMENT RADIATEUR ROBINETTERIE INTEGREE

- HEIMEIER



REFERENCE IMS	CODE FOURNISSEUR	DESIGNATION		HT €
A65T00014	0567-50.000	VEKOTRIM COUDE MALE G3/4 OU 20/27 ENTRAXE 50mm	NS	12,72

CHAUFFE-EAU ELECTRIQUE

DURALIS -HORIZONTALS MURAUX

CAPACITE (L)	nombre de personne	Diam. x h x P (mm)	classe énergétique
100	2	580 x 860 x 530	C
150	3	580 x 1180 x 530	C
200	4	580 x 1510 x 530	C



REFERENCE IMS	CODE FOURNISSEUR	DESIGNATION		HT €
767273024	273124	CHAUFFE-EAU DURALIS150L 1800W HZ MO	NS	642,32

- PETITE CAPACITE SUR EVIER



REFERENCE IMS	CODE FOURNISSEUR	DESIGNATION		HT €
IM024263	221078	CHAUFFE-EAU CARRE 15L 2000W SUR EVIER	NS	228,66
IM024265	221080	CHAUFFE-EAU CARRE 30L 2000W SUR EVIER	NS	250,59

CHAUFFE-EAU ECHANGEUR (PREPARATEUR ECS)

- A ECHANGEUR ANNULAIRE



REFERENCE IMS	CODE FOURNISSEUR	DESIGNATION		HT €
767274012	874428	PECS 150L ANNULAIRE MULTIPOSITION DURALIS	NS	1116,22

CHAUFFAGE

CHAUFFE-EAU ECHANGEUR (PREPARATEUR ECS) ...

SERPENTIN



REFERENCE IMS	CODE FOURNISSEUR	DESIGNATION		HT €
767874410	874410	PECS 150L SERPENTIN MURAL DURALIS	NS	872,53
767884409	884409	PECS 200L SERPENTIN MURAL DURALIS	NS	1004,18



REFERENCE IMS	CODE FOURNISSEUR	DESIGNATION		HT €
767900548	900548	KIT ELEC SERP STEATITE 150-200L	NS	106,32

ACCESSOIRE POUR CHAUFFE-EAU

ROBINETTERIE



REFERENCE IMS	CODE FOURNISSEUR	DESIGNATION		HT €
469MELSE	MELSE	MELANGEUR MONOTROU EVIER C.E MELSE	NS	121,39

GROUPE DE SECURITE

WATTS



REFERENCE IMS	CODE FOURNISSEUR	DESIGNATION		HT €
48154310	2254310M2	GROUPE DE SECURITE DROIT 15/21	NS	28,45

PIECE DE RECHANGE

CORPS DE CHAUFFE



REFERENCE IMS	CODE FOURNISSEUR	DESIGNATION		HT €
D13T00004	030137	CORPS DE CHAUFFE ACI HYBRIDE SS + JOINT	NS	118,82



REFERENCE IMS	CODE FOURNISSEUR	DESIGNATION		HT €
767040142	040142	CORPS DE CHAUFFE STE STD 100L 040142	NS	83,54
D13T00016	901027	KIT TRI 3000W POUR STEATIS STABLES	NS	62,38



REFERENCE IMS	CODE FOURNISSEUR	DESIGNATION		HT €
76760175	060175	RESISTANCE STE ACI 150L D47 1800W 060175	NS	63,79
76760174	060174	RESISTANCE STE ACI 200L D47 2400W 060174	NS	75,55

CHAUFFAGE

THERMOR

● THERMOR SPLIT AEROMAX RT2012



REFERENCE IMS	CODE FOURNISSEUR	DESIGNATION	HT €
767296515	296515	CHAUFFE-EAU AEROMAX SPLIT 2 VM 200L	1411,57
767296514	296514	CHAUFFE-EAU AEROMAX SPLIT 2 VS 270L	NS 1674,44
767232399	232399	UNITE EXTERIEURE INVERTER AEROMAX SPLIT2	589,98

PROPANE

● INDICATEUR DE RESERVE



REFERENCE IMS	CODE FOURNISSEUR	DESIGNATION	HT €
37712580	12580	INDICATEUR SERVICE RESERVE PROPANE	NS 28,88

STATION SOLAIRE



REFERENCE IMS	CODE FOURNISSEUR	DESIGNATION	HT €
A72B00013	303D-06-PST6	STATION SOLAIRE COMPLETE 1-6L/minute en 3/4"	NS 440,69



REFERENCE IMS	CODE FOURNISSEUR	DESIGNATION	HT €
IM060459	7809904	STATION SOLAIRE SKP 7-8 ER655	NS 472,03

PREPARATEUR ECS



Préparateurs solaires non équipés avec appoint hydraulique (et électrique en option) pour la préparation d'e.c.s. dans l'habitat individuel ou collectif

Température maximale de service:

- primaire (échangeurs): 110 °C
- secondaire (cuve): 95 °C

Pression de service maximale:

- primaire (échangeurs): 10 bar
- secondaire (cuve): 10 bar



REFERENCE IMS	CODE FOURNISSEUR	DESIGNATION	HT €
IM054591	100019522	PREPARATEUR SOLAIRE OBS 300 N 1000 DOUBLE ECHANGEUR	1110,60

CHAUFFAGE

LIAISON SOLAIRE



REFERENCE IMS	CODE FOURNISSEUR	DESIGNATION	HT €
A25X00001	3032067	LIAISON SOLAIRE INOX 2X16 LONG 15ML 2216015	NS 646,23
IM052327	TS14X16X50SR	TWIN SOLAR FLEXIBLE INOX 2 X DN 16 Longueur 50ml	NS 31,25



REFERENCE IMS	CODE FOURNISSEUR	DESIGNATION	HT €
A25X00005	3032940	RACCORD FILETE MALE DN16 M 3/4"	NS 14,44
A25X00006	3032947	RACCORD FILETE MALE DN16 M 1"	NS 10,89



REFERENCE IMS	CODE FOURNISSEUR	DESIGNATION	HT €
A25X00007	3032937	RACCORD FILETE FEMELLE DN16 F 3/4"	NS 14,44
A25X00008	3032944	RACCORD FILETE FEMELLE DN16 F 1"	NS 9,56



REFERENCE IMS	CODE FOURNISSEUR	DESIGNATION	HT €
IM071898	A180190	COLLIER DE LIAISON POUR ISOLATION SOLAIRE - JEU DE 5	9,65

ACCESSOIRE SOLAIRE



REFERENCE IMS	CODE FOURNISSEUR	DESIGNATION	HT €
469MT252720C	MT252720C	MITIGEUR THERMOSTATIQUE C.E SOLAIRE 3/4" M	89,03



REFERENCE IMS	CODE FOURNISSEUR	DESIGNATION	HT €
318C01400006	7809853	FLUIDE CALOPORTEUR SOLAIRE 20L	NS 112,00

CLIMATISATION

MONOSPLIT MURAL



REFERENCE IMS	CODE FOURNISSEUR	DESIGNATION	HT €
IM070862	873197	UNITE INT ASYG14KMCC TAKAO M2 CONFORT R32 900/4400W 3/8-1/4	NS 579,33

ACCESSOIRE

- SUPPORT UNITE EXTERIEUR



REFERENCE IMS	CODE FOURNISSEUR	DESIGNATION	HT €
IM221486	167BB00386V	RUBBER FOOT FIX-IT 600MM AVEC VISSERIE	NS 23,90

VENTILATION

PAVILLONNAIRE

● KIT HYGROREGLABLE BASSE CONSOMMATION

ACCESSOIRES BAINS / WC ET CUISINE



REFERENCE IMS	CODE FOURNISSEUR	DESIGNATION		HT €
IM074290	9912	BOUCHE ALYZE HYGRO SALLE DE BAIN ANJOS 10/40 + MANCHON PLACO D 80 MM	NS	29,61
IM074291	9972P	BOUCHE ALYZE HYGRO VISION WC A PILES 5/30 M3/H AC MANCHON PLACO D80 MM	NS	42,43

SANITAIRE

RECEVEUR

- ONYX SYNTHESE

AKW



REFERENCE IMS	CODE FOURNISSEUR	DESIGNATION		HT €
IM007586	11851	RECEVEUR ONYX BLANC 1000*800MM	NS	327,22
IM025241	11853	RECEVEUR ONYX BLANC 1200*800MM	NS	236,39
IM011768	11859	RECEVEUR ONYX BLANC 1600*900MM	NS	308,59
IM074294	11886	RECEVEUR ONYX BLANC 800 X 800MM	NS	190,42

- BONDE NICOLL

Nicoll
by aliaxis



REFERENCE IMS	CODE FOURNISSEUR	DESIGNATION		HT €
631TBS01	0205391	BONDE TURBOSOL A BACHE TBS01 + SIPHON 120X120CM	NS	182,87

NOVELLINI GAMME SAMBA CADREE HT 1850MM VERRE

- PAROI FIXE HT 185CM POUR MONTAGE AVEC PORTE

NOVELLINI
STOCK PLATEFORME



REFERENCE IMS	CODE FOURNISSEUR	DESIGNATION		HT €
IM006838	SAMBAFC100-1A	PAROI FIXE 100CM SAMBAFC100-1A 98/102CM	NS	202,26

COLONNE DE DOUCHE THERMOSTATIQUE

- HANSGROHE

hansgrohe



REFERENCE IMS	CODE FOURNISSEUR	DESIGNATION		HT €
59427264400	27264400	COLONNE CROMETA 160 RECOUPABLE 1 jet douche de tête 160mm	NS	556,04

ACCESSOIRE ENCASTREMENT

- HANSGROHE

hansgrohe



REFERENCE IMS	CODE FOURNISSEUR	DESIGNATION		HT €
59427476000	27476000	DOUCHE DE TETE RAINDANCE D.180mm	NS	566,22

BARRE DE DOUCHE

- JACOB DELAFON

Jacob Delafon
PARIS



REFERENCE IMS	CODE FOURNISSEUR	DESIGNATION		HT €
IM168347	E14325-CP	ENSEMBLE DOUCHE BASIC 1 BAR 60 2 JETS FL	NS	72,70
IM169849	E14320-CP	ENSEMBLE DOUCHE ECO BARRE 60 1 JET FLEX	NS	39,66
IM169852	E14331-CP	ENSEMBLE DOUCHE BASIC 2 3 JETS FL.175 SU	NS	48,22

SANITAIRE

BARRE DE DOUCHE ...

- JACOB DELAFON ...



REFERENCE IMS	CODE FOURNISSEUR	DESIGNATION	HT €
IM169851	E99938-CP	ENSEMBLE DE DOUCHE EO SMALL	NS 95,02

GARNITURE DOUCHE BAIGNOIRE

- NICOLL



REFERENCE IMS	CODE FOURNISSEUR	DESIGNATION	HT €
IM003764	0343068	SET DE DOUCHE PR BAIGNOIRE SUPPORT MURAL FLEXIBLE 175CM	NS 46,05

- JACOB DELAFON



REFERENCE IMS	CODE FOURNISSEUR	DESIGNATION	HT €
IM169850	E14321-CP	SET BAIGNOIRE ECO 1 JET FLEX 175 SUPP.MU	NS 25,84

DOUCHETTE

- HANSGROHE



REFERENCE IMS	CODE FOURNISSEUR	DESIGNATION	HT €
59428561000	28561000	DOUCHETTE GREEN 85 ECOSMART 6L/MN	NS 37,26

ENSEMBLE DE DOUCHE

- FIMA



REFERENCE IMS	CODE FOURNISSEUR	DESIGNATION	HT €
580F4079CRWS	F4079CR.ES	ENSEMBLE ROBINETTERIE DOUCHE ET LAVABO	NS 211,49

SANITAIRE

SUPPORT MURAL

● NICOLL

Nicoll
by aliaxis



REFERENCE IMS	CODE FOURNISSEUR	DESIGNATION	HT €
63118000	0310031	SUPPORT MURAL ORIENTABLE	12,58



REFERENCE IMS	CODE FOURNISSEUR	DESIGNATION	HT €
IM176318	0310036	SUPPORT MURAL ORIENTABLE	12,35

● GEBERIT UP320

■ GEBERIT



REFERENCE IMS	CODE FOURNISSEUR	DESIGNATION	HT €
577115778KN1	115.882.KN.1	PLAQUE SIGMA20 CHROME MAT/BRILLANT	124,29



REFERENCE IMS	CODE FOURNISSEUR	DESIGNATION	HT €
IM003661	115.883.KN.1	PLAQUE DE CDE SIGMA 30 CHROME MAT/CHROME	149,72

CUVETTE

● GEBERIT

■ GEBERIT



REFERENCE IMS	CODE FOURNISSEUR	DESIGNATION	HT €
B10S00003	00396700000	CUVETTE SUSPENDUE BASTIA 52X36cm	52,21



REFERENCE IMS	CODE FOURNISSEUR	DESIGNATION	HT €
63400396710000	00396710000	CUVETTE SUSPENDUE BASTIA SANS TROUS ABATTANT BLANC	109,94

PACK CUVETTE

● JACOB DELAFON

Jacob Delafon
PARIS



REFERENCE IMS	CODE FOURNISSEUR	DESIGNATION	HT €
IM170318	EDV114-00	PACK WC SUSPENDU PATIO SANS BRIDE	180,77

CUVETTE

● INDEPENDANTE

■ GEBERIT



REFERENCE IMS	CODE FOURNISSEUR	DESIGNATION	HT €
B50S00001	08363900000300	CUVETTE PUBLICA INDEPENDANTE SORTIE HORIZONTALE	100,77

ABATTANT

GEBERIT



REFERENCE IMS	CODE FOURNISSEUR	DESIGNATION	HT €
B85S00003	00046300000	ABATTANT ROYAN3 MINI	49,93

RESERVOIR

- REGIPLAST-ORCAB



REFERENCE IMS	CODE FOURNISSEUR	DESIGNATION	HT €
6211200	1200	RESERVOIR STANDARD SEMI-BAS LIVRÉ COMPLET AVEC TUBE DE CHASSE 50/40	50,49

ROBINET FLOTTEUR

- REGIPLAST



REFERENCE IMS	CODE FOURNISSEUR	DESIGNATION	HT €
621220	0220	ROBINET FLOTEUR WC UNI-BAS	11,73



REFERENCE IMS	CODE FOURNISSEUR	DESIGNATION	HT €
621250	0250	ROBINET FLOTEUR WC 3/8 A FERM. MECANIQUE	18,22

FIXATION

- SIAMP

SIAMP



REFERENCE IMS	CODE FOURNISSEUR	DESIGNATION	HT €
63734031901	34031901	JOINT DE CUVETTE (ENTRE RESERV ET CUV)	2,55

SANITAIRE

DE FACE - CERAMIQUE

● GEBERIT



REFERENCE IMS	CODE FOURNISSEUR	DESIGNATION	HT €
B01S00008	0010450000	LAVE MAINS BASTIA 45X32cm	33,74



REFERENCE IMS	CODE FOURNISSEUR	DESIGNATION	HT €
B01S00017	276145000	LAVE MAINS RENOVA COMPACT 45x34cm	110,52

MEUBLE LAVE-MAINS

● NEOVA



REFERENCE IMS	CODE FOURNISSEUR	DESIGNATION	HT €
IM070813	A2346708	MEUBLE LAVE-MAINS PALERME RAZOR BLANC 40CM	77,07

MUNDO



● 60CM SOUS VASQUE PORTE ET AVEC TIROIR



REFERENCE IMS	CODE FOURNISSEUR	DESIGNATION	HT €
IM009672	553032	PLAN MUNDO SYNTHÈSE 1V BL 60CM	102,96

● 70CM SOUS VASQUE AVEC PORTE



REFERENCE IMS	CODE FOURNISSEUR	DESIGNATION	HT €
IM009673	553033	PLAN MUNDO SYNTHÈSE 1V BL 70CM	104,83

● 100CM SOUS VASQUE AVEC TIROIR



REFERENCE IMS	CODE FOURNISSEUR	DESIGNATION	HT €
IM009675	553036	PLAN MUNDO SYNTHÈSE 1 VASQUE BLANC 100CM	135,47

● 120CM SOUS VASQUE PORTE ET AVEC TIROIR



REFERENCE IMS	CODE FOURNISSEUR	DESIGNATION	HT €
IM009676	553039	PLAN MUNDO SYNTHÈSE 2V BL 120CM	162,86

SANITAIRE

COCOON

- ARMOIRE DE TOILETTE L90CM



REFERENCE IMS	CODE FOURNISSEUR	DESIGNATION	HT €
IM072924	A2373711	ARMOIRE DE TOILETTE AVEC NICHE L90 CM NOIR MAT, 2 PORTES BATT. MIROIR	NS 247,98

- PIED



REFERENCE IMS	CODE FOURNISSEUR	DESIGNATION	HT €
IM022171	A2342649	LOT 2 PIEDS RÉGLABLES, NOIR MAT	NS 40,56

CARLO FRATTINI

- SERIE MATRIX



REFERENCE IMS	CODE FOURNISSEUR	DESIGNATION	HT €
580F3531CR	F3531CR.WS	MITIGEUR LAVABO CHR. VIDAGE LAITON	NS 95,22

- SERIE TALIS S



REFERENCE IMS	CODE FOURNISSEUR	DESIGNATION	HT €
59414870000	14870000	MITIGEUR EVIER TALIS S2 BEC HAUT	NS 320,40

GROHE

- SERIE BAUEDGE



REFERENCE IMS	CODE FOURNISSEUR	DESIGNATION	HT €
IM193041	23760001	BAUEDGE MITIGEUR LAVABO L	NS 78,48

SANITAIRE

GROHE ...

● SERIE BAUEDGE ...



REFERENCE IMS	CODE FOURNISSEUR	DESIGNATION	HT €
IM179259	23559001	MITIGEUR LAVABO TAILLE S	57,70



REFERENCE IMS	CODE FOURNISSEUR	DESIGNATION	HT €
IM178810	23763001	MITIGEUR LAVABO BAULOOP L	112,52



REFERENCE IMS	CODE FOURNISSEUR	DESIGNATION	HT €
IM178948	23887001	MITIGEUR LAVABO BAULOOP M	87,59

● SERIE EUROSMART



REFERENCE IMS	CODE FOURNISSEUR	DESIGNATION	HT €
B30O00003	32926002	MITIGEUR LAVABO TAILLE S EUROSMART	64,83



REFERENCE IMS	CODE FOURNISSEUR	DESIGNATION	HT €
B30O00005	23537002	MITIGEUR LAVABO BEC HAUT PIVOTANT EUROSMART	114,53



REFERENCE IMS	CODE FOURNISSEUR	DESIGNATION	HT €
B30O00008	33412002	MITIGEUR B/D MECA MONOTROU EUROSMART	100,04

● THERMOSTATIQUE DOUCHE ET BAIN DOUCHE



REFERENCE IMS	CODE FOURNISSEUR	DESIGNATION	HT €
IM075096	34781000	MITIGEUR THERMOSTATIQUE DOUCHE	209,40

FRANKE



REFERENCE IMS	CODE FOURNISSEUR	DESIGNATION		HT €
IM003761	688684	ROBINET MARIS, DOUCHETTE EXTRACTIBLE, GRAPHITE	NS	327,08
IM003762	688677	ROBINET MARIS, DOUCHETTE EXTRACTIBLE, STONE	NS	327,08



REFERENCE IMS	CODE FOURNISSEUR	DESIGNATION		HT €
IM070521	115.0550.427	MITIGEUR EVIER DOUCHETTE ATLAS INOX NOIR 552646	NS	531,96

AKW

- SERIE ECO CHROME



REFERENCE IMS	CODE FOURNISSEUR	DESIGNATION		HT €
IM002496	01244-HD	BARRES D'APPUI INOX MAIN COURANTE EN L 4	NS	179,97

EVIER A ENCASTRER

- MODERNA



REFERENCE IMS	CODE FOURNISSEUR	DESIGNATION		HT €
606EVE11528	EEBM116A03	EVIER A ENCASTRER INOX 2 CUVES 1 EG 116X50cm	NS	140,03

EVIER A ENCASTRER SYNTHESE

- JASPE



REFERENCE IMS	CODE FOURNISSEUR	DESIGNATION		HT €
IM006954	579746	EVIER JASPE 1Cuve 1/2 1Egouttoir 97X50cm VIDAGE MANUEL GRAPHITE	NS	162,43



REFERENCE IMS	CODE FOURNISSEUR	DESIGNATION		HT €
581095515	095515	EVIER SIRIUS 1Cuve 1/2 1Egouttoir 100X51cm CARBONE	NS	224,18

SANITAIRE

EVIER A ENCASTRER SYNTHESE FRANKE ...

- JASPE ...



REFERENCE IMS	CODE FOURNISSEUR	DESIGNATION	HT €
581095546	095546	EVIER SIRIUS 2Cuves 1Egouttoir 119X51cm TITANIUM	NS 279,30



REFERENCE IMS	CODE FOURNISSEUR	DESIGNATION	HT €
IM014146	579760	EVIER JASPE 1Cuve 1/2 1Egouttoir 970X500MM VIDAGE MANUEL BLC ARTIC	NS 162,43

CUISINETTE

- CUISINETTE VITRO OU INDUCTION

Moderna



REFERENCE IMS	CODE FOURNISSEUR	DESIGNATION	HT €
IM184452	CPBD120A10	EV CUISINETTE INOX 1C+DEC 1200	NS 254,12



REFERENCE IMS	CODE FOURNISSEUR	DESIGNATION	HT €
IM184110	MTCD031Z00	DOMINO 2FEUX VITRO MANETTES	NS 390,15



REFERENCE IMS	CODE FOURNISSEUR	DESIGNATION	HT €
IM184109	MTES031Z00	DOMINO MT+ 2 FEUX INDUCTION MTES	NS 453,79

**NORD
INOX
PRO**



REFERENCE IMS	CODE FOURNISSEUR	DESIGNATION	HT €
IM201598	MC12055601P	MEUBLE CUISINETTE 120CM 1PTE	NS 71,82



REFERENCE IMS	CODE FOURNISSEUR	DESIGNATION	HT €
IM201596	PE1200NU	EVIER CUISINETTE 120CM 2 PLAQUES ELECTRI	NS 185,53

CUVE SOUS PLAN SYNTHESE

- FRANKE

FRANKE



REFERENCE IMS	CODE FOURNISSEUR	DESIGNATION	HT €
IM219474	151756	CUVE 55,3X43,3CM ONYX MRG110-52 VIDAGE AUTO FRAGRANIT	NS 392,80

SANITAIRE

CUVE SOUS PLAN INOX

- FRANKE



REFERENCE IMS	CODE FOURNISSEUR	DESIGNATION	HT €
581059586	059586	CUVE GALASSIA Avec vidage automatique INOX MICRO DEKOR 48X43cm	NS 305,29

TEMPORISE

- DOUCHE



REFERENCE IMS	CODE FOURNISSEUR	DESIGNATION	HT €
570714002	714002	SPORTING KIT DOUCHE MUR.ENCAS.(ET PANNEAU)	NS 279,07

DOUCHE

- BONDE NICOLL



REFERENCE IMS	CODE FOURNISSEUR	DESIGNATION	HT €
6316001	0206001	TUYAU SOUPLE D32 650MM + DOUILLE	NS 13,03

EVIER

- BONDE A GRILLE D'EVIER

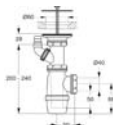

REFERENCE IMS	CODE FOURNISSEUR	DESIGNATION	HT €
597D5870AA	D5870AA	BONDE A GRILLE EVIER D60 CHROME	NS 20,32

POMME DE DOUCHE

- DELABIE



REFERENCE IMS	CODE FOURNISSEUR	DESIGNATION	HT €
570711000	711000	GYM CONFORT POMME ANTITARTRE F1/2' Ø 46	NS 46,83



REFERENCE IMS	CODE FOURNISSEUR	DESIGNATION	HT €
5709690122P	969012.2P	REDUCTIONS DE BEC M1/2' M15/75	NS 4,08
5709690182P	969018.2P	REDUCTIONS DE BEC M1/2' M18/100	NS 4,08
5709690192P	969019.2P	REDUCTIONS DE BEC M1/2' M19/100	NS 4,08
5709690202P	969020.2P	REDUCTIONS DE BEC M1/2' M20/100	NS 4,07
5709696222P	969622.2P	REDUCTIONS DE BEC M1/2' M22/125	NS 5,97
5709758222P	975822.2P	REDUCTIONS DE BEC M1/2' F22/150	NS 10,58

ELECTRICITE

FIL RIGIDE

- HO7 VR (AME CUIVRE CABLE RIGIDE)



REFERENCE IMS	CODE FOURNISSEUR	DESIGNATION	HT €
EASNR3XVR6	10198960	EASYFIL 3HO7VR6 RECHARGE N ROLL 75ML	NS 3,71

GAINE PREFILEE

- COURANT FORT



REFERENCE IMS	CODE FOURNISSEUR	DESIGNATION	HT €
PRE3X1,5ROO	F1U15AAR	GAINE PREFIL D16 3X1,5 RO-OR-OR	NS 0,89

COFFRET RESI9

- GTL 13 MODULES



REFERENCE IMS	CODE FOURNISSEUR	DESIGNATION	HT €
D23S00060	R9H13531	CLOISON+CAPOT ERDF RESI9	NS 12,11

- DISJONCTEUR DT40 COURBE D 6KA

TRI + NEUTRE



REFERENCE IMS	CODE FOURNISSEUR	DESIGNATION	HT €
737MG21078	A9N21078	DISJONCTEUR DT40 3P N 32A D 6KA	NS 135,54

COFFRET DE DISTRIBUTION

- ACCESSOIRE GALEO



REFERENCE IMS	CODE FOURNISSEUR	DESIGNATION	HT €
IM014315	190034	REHAUSSE UNIVERSELLE 2 METRES	NS 41,19

- COFFRET DE COMMUNICATION GALEO



Coffret 4R345 + TV

REFERENCE IMS	CODE FOURNISSEUR	DESIGNATION	HT €
IM004855	HQ215802	COFFRET DE COMMUNICATION GALEO VDI GRADE 2 (4RJ45 + TV)	NS 107,86

ELECTRICITE

COFFRET DE DISTRIBUTION ABB ...

● ACCESSOIRE COFFRET DE COMMUNICATION



REFERENCE IMS	CODE FOURNISSEUR	DESIGNATION		HT €
700190375	190375	LOT DE 4 CONNECTEURS RJ45 GRADE 2 / CAT 6	NS	45,80
700190372	190372	LOT DE 4 SUPPORTS MODULAIRES POUR CONNEC TEURS RJ45	NS	17,16

COFFRET ETANCHE / ARMOIRE DE DISTRIBUTION

● COFFRET MISTRAL IP65



REFERENCE IMS	CODE FOURNISSEUR	DESIGNATION		HT €
700153748	151220	COFFRET MISTRAL IP65 8M	NS	31,53



REFERENCE IMS	CODE FOURNISSEUR	DESIGNATION		HT €
700153755	151224	COFFRET MISTRAL IP65 36M 2 RANGEES	NS	124,72

● ARMOIRE DE DISTRIBUTION (250A)

ACCESSOIRE COMMUN TYP A ET FS



REFERENCE IMS	CODE FOURNISSEUR	DESIGNATION		HT €
700173671	173671	POCHETTE PORTE PLANS TYPE A/FS	NS	9,54
700173678	173678	SUPPORT BRACELET FIL. A/FS (X10)	NS	54,89

REPARTITEUR



REFERENCE IMS	CODE FOURNISSEUR	DESIGNATION		HT €
IM024210	190221	REPARTITEUR MODULAIRE 125A	NS	43,94
IM024211	190222	REPARTITEUR MODULAIRE 160A	NS	102,79

● ARMOIRE THERMOPLASTIQUE IP66 GEMINI

ACCESSOIRE COMMUN TYP A ET FS



REFERENCE IMS	CODE FOURNISSEUR	DESIGNATION		HT €
700150286	150286	MONTANT GEMINI TAILLE 5	NS	55,48
700150342	150342	PATTES DE FIXATION	NS	19,13

● CONTACTEUR DE PUISSANCE



REFERENCE IMS	CODE FOURNISSEUR	DESIGNATION		HT €
70026796	26796	CONTACTEUR ESB 24-04 230V 4O 24A	NS	56,48
70026936	26936	CONTACTEUR ESB 63-30 230V 3F 63A	NS	103,57

ELECTRICITE

DISJONCTEUR

DISJONCTEUR BI/TRI/TETRA-TERTIAIRE

DS941 4500 6kA PH/N
(Remplacé progressivement par DS201L)



REFERENCE IMS	CODE FOURNISSEUR	DESIGNATION	HT €
700430040	471015	DISJ DIFF DS941/201L 6KA C 25A 30MA	NS 78,28

DISJONCTEUR MOTEUR

DISJONCTEUR MOTEUR MS16

ACCESSOIRE MS 116



REFERENCE IMS	CODE FOURNISSEUR	DESIGNATION	HT €
IM013667	141121	CONTACTEUR AUX LATERAL DROIT 1NO+1NF MS1	NS 14,80



REFERENCE IMS	CODE FOURNISSEUR	DESIGNATION	HT €
IM176520	T222531	HORLOGE SEMAINE DIGITALE DW1	NS 89,10

APPAREILLAGE SCHNEIDER

ODACE MECANISME TECHNIQUE BLANC

THERMOSTAT ELECTRONIQUE



REFERENCE IMS	CODE FOURNISSEUR	DESIGNATION	HT €
704S520501	S520501	ODACE THERMOSTAT BLANC 8A	NS 74,96

ODACE MECANISME ALU

COMMANDE DOUBLE



REFERENCE IMS	CODE FOURNISSEUR	DESIGNATION	HT €
704S530273	S530273	ODACE VV LUM + VV ALU	NS 25,80

ELECTRICITE

APPAREILLAGE SCHNEIDER ...

● ODACE MECANISME ALU ...

PRISE DE COURANT



REFERENCE IMS	CODE FOURNISSEUR	DESIGNATION	HT €
704S530099	S530099	ODACE PC 2P+T ALU DETROMPE	NS 13,55

PRISE DE COM ALU TV / RJ45 / TEL / HP



REFERENCE IMS	CODE FOURNISSEUR	DESIGNATION	HT €
704S530460	S530460	ODACE TV/FM/SAT AL 2E VIS	NS 36,82



REFERENCE IMS	CODE FOURNISSEUR	DESIGNATION	HT €
704S530488	S530488	ODACE PRISE HP ALU 2S VIS	NS 17,31



REFERENCE IMS	CODE FOURNISSEUR	DESIGNATION	HT €
704S530457	S530457	ODACE MULTISERV ALU VIS	NS 40,54



REFERENCE IMS	CODE FOURNISSEUR	DESIGNATION	HT €
704S530486	S530486	ODACE DBL RJ45 ALU GRADE3	NS 39,43

● ODACE MECANISME TECHNIQUE ALU

SIGNALISATION SONORE



REFERENCE IMS	CODE FOURNISSEUR	DESIGNATION	HT €
704S530580	S530580	ODACE SONNETTE ELECTR ALU	NS 73,78



REFERENCE IMS	CODE FOURNISSEUR	DESIGNATION	HT €
704S530685	S530685	ODACE RONFLEUR ALU	NS 44,44

THERMOSTAT ELECTRONIQUE



REFERENCE IMS	CODE FOURNISSEUR	DESIGNATION	HT €
704S530507	S530507	ODACE THERMOSTAT SOL ALU	NS 95,75



REFERENCE IMS	CODE FOURNISSEUR	DESIGNATION	HT €
704S530501	S530501	ODACE THERMOSTAT ALU 8A	NS 90,00

ENJOLIVEUR SPECIFIQUE



REFERENCE IMS	CODE FOURNISSEUR	DESIGNATION	HT €
704S530297	S530297	ODACE ENJOLIVEUR ALU SANS LED	NS 11,93

ELECTRICITE

APPAREILLAGE SCHNEIDER ...

● ODACE MECANISME TECHNIQUE ALU ...



REFERENCE IMS	CODE FOURNISSEUR	DESIGNATION	HT €
704S530298	S530298	ODACE 2 DEMI-ENJOLIVEUR ALU NS	10,24



REFERENCE IMS	CODE FOURNISSEUR	DESIGNATION	HT €
704S520722	S520722	ODACE STYL PLAQUE CROCHET NS	11,81

● ODACE MECANISME ANTHRACITE

DETECTEUR



REFERENCE IMS	CODE FOURNISSEUR	DESIGNATION	HT €
IM076544	S540525	ODACE DETECT TT CHARG ANTH NS	74,17

● ODACE TOUCH LISERE BLANC

ENTRAXE 57MM BLANC MAT



REFERENCE IMS	CODE FOURNISSEUR	DESIGNATION	HT €
704S520816	S520816	ODACE TOUCH BLANC 3P57 NS	7,38

ENTRAXE 57MM ALU BROSE



REFERENCE IMS	CODE FOURNISSEUR	DESIGNATION	HT €
704S530814J	S530814J	ODACE TOUCH ALUB ALU 2P57 NS	20,31

ENTRAXE 71MM ALU MARTELE



REFERENCE IMS	CODE FOURNISSEUR	DESIGNATION	HT €
704S520802K	S520802K	ODACE TOUCH ALUMAR ALU 1P NS	8,93
704S520806K	S520806K	ODACE TOUCH ALUM ALU 3P71 NS	40,48
704S520808K	S520808K	ODACE TOUCH ALUM ALU 4P71 NS	53,22

ENTRAXE 57MM ALU MARTELE



REFERENCE IMS	CODE FOURNISSEUR	DESIGNATION	HT €
704S520814K	S520814K	ODACE TOUCH ALUM ALU 2P57 NS	21,43
704S520816K	S520816K	ODACE TOUCH ALUM ALU 3P57 NS	40,48

ENTRAXE 71MM WENGE



REFERENCE IMS	CODE FOURNISSEUR	DESIGNATION	HT €
704S530802P	S530802P	ODACE TOUCH WENGE ALU 1P NS	15,27
704S530804P	S530804P	ODACE TOUCH WENG ALU 2P71 NS	35,63
704S530806P	S530806P	ODACE TOUCH WENG ALU 3P71 NS	69,89

ELECTRICITE

APPAREILLAGE SCHNEIDER ...

● ODACE TOUCH LISERE BLANC ...

ENTRAXE 57MM WENGE



REFERENCE IMS	CODE FOURNISSEUR	DESIGNATION		HT €
704S530814P	S530814P	ODACE TOUCH WENG ALU 2P57	NS	35,63
704S530816P	S530816P	ODACE TOUCH WENG ALU 3P57	NS	69,89

● GAMME OVALIS ANTHRACITE

PRISE USB



REFERENCE IMS	CODE FOURNISSEUR	DESIGNATION		HT €
IM192284	S461401	PRISE DOUBLE USB TYPEA+C ANTHRACITE	NS	41,39

APPAREILLAGE HAGER



● APPAREILLAGE ESSENSYA



REFERENCE IMS	CODE FOURNISSEUR	DESIGNATION		HT €
IM059158	WE002	ESSENSYA INTER VV A VOYANT	NS	7,85



REFERENCE IMS	CODE FOURNISSEUR	DESIGNATION		HT €
IM059165	WE050	ESSENSYA INTER AUTO. IR 2 FILS	NS	78,69



REFERENCE IMS	CODE FOURNISSEUR	DESIGNATION		HT €
IM059164	WE048	ESSENSYA INTER VV VMC	NS	10,19



REFERENCE IMS	CODE FOURNISSEUR	DESIGNATION		HT €
IM069224	WS690	ESSENSYA LAMP.SIGNAL.250V BLEU	NS	7,08

ELECTRICITE

APPAREILLAGE HAGER ...

● APPAREILLAGE GALLERY

COMMANDE VOLET ROULANT



REFERENCE IMS	CODE FOURNISSEUR	DESIGNATION	HT €
IM069512	WXF301	BOUTON-POUSOIR VOLET ROULANT	NS 22,42

SOURCE

● LED

LAMPE LED TUBE



REFERENCE IMS	CODE FOURNISSEUR	DESIGNATION	HT €
IM009242	593350	LAMPE LED 10W E27 2700K BC 1050LM TUBE	NS 5,09
IM009243	593336	LAMPE LED 10W E27 4000K BF 1100LM TUBE	NS 5,09

LAMPE LED CLASSIQUE TOLEDO



REFERENCE IMS	CODE FOURNISSEUR	DESIGNATION	HT €
IM014686	0026668	LAMPE LED E27 10W 850LM 840 SLI	NS 3,43



REFERENCE IMS	CODE FOURNISSEUR	DESIGNATION	HT €
D73X00117	0027341	LAMPE LED TOLEDO RETRO 6W 806LM E27 827	NS 4,46



REFERENCE IMS	CODE FOURNISSEUR	DESIGNATION	HT €
IM016298	592032	LAMPE LED 7W/827 E27 806LM 230V	NS 3,84



REFERENCE IMS	CODE FOURNISSEUR	DESIGNATION	HT €
7600025156	0025915	LAMPE FC LYNX DOUBLE 26W/840 G24D3	NS 4,26

LED G4 12V



REFERENCE IMS	CODE FOURNISSEUR	DESIGNATION	HT €
IM001290	79023	LAMPE LED G4 1,5W 120LM 3000K BC MIDEX	NS 2,51

● LAMPE HALOGENE



REFERENCE IMS	CODE FOURNISSEUR	DESIGNATION	HT €
7600021717	0021717	LAMPE HALOGENE R7S ECO 118MM 230W 230V	NS 4,04

ELECTRICITE

SOURCE ...

● LAMPE HALOGENE ...



REFERENCE IMS	CODE FOURNISSEUR	DESIGNATION	HT €
7072929	2929	LPE LED R7S 10W/3000K 118MM	17,25
7072972	2972	LPE LED R7S 10W/4000K 118MM	16,62
D73X00108	2928	LPE LED R7S 6W/4000K 78MM 700LM	12,93

● LAMPE FLUOCOMPACTE



REFERENCE IMS	CODE FOURNISSEUR	DESIGNATION	HT €
7600025152	0025914	LAMPE FC LYNX DOUBLE 18W/840 G24D2	NS 5,59

● TUBE FLUORESCENT



D16 T5 MINIATURE



REFERENCE IMS	CODE FOURNISSEUR	DESIGNATION	HT €
7600000382	0000382	TUBE FLUO MINI T5 8W WW G5	NS 5,28

● DOUILLE,BALLAST,TRANSFO,STARTER,ALIM



REFERENCE IMS	CODE FOURNISSEUR	DESIGNATION	HT €
72247291	147291	DOUILLE E27 1/2FIL.+BAG. BLC M10	NS 3,64

ECLAIRAGE INTERIEUR

● SPOT ENCASTRE 12V

KIT SPOT A ENCASTRER 12V TBT



REFERENCE IMS	CODE FOURNISSEUR	DESIGNATION	HT €
7074910	4910	KIT SPOT TBT GU5,3 ORIEN BLC + LP + CONV	NS 12,06

● SPOT ETANCHE

SPOT MONOBLOC IP44



REFERENCE IMS	CODE FOURNISSEUR	DESIGNATION	HT €
IM055818	0005371	SPOT LED 5W 480LM 4000K BF IP44 AUTO ORIENTABLE	NS 9,24



REFERENCE IMS	CODE FOURNISSEUR	DESIGNATION	HT €
IM055817	0005374	SPOT LED 6,5W 600LM 4000K BF IP65 AUTO	NS 12,75

ELECTRICITE

ECLAIRAGE INTERIEUR ...

● KIT LED

Kit spot LED GU10 SYLVANIA non dimmable

SYLVANIA



REFERENCE IMS	CODE FOURNISSEUR	DESIGNATION	HT €
D73X00110	3001770	KIT LED ORIENTABLE GU10 6W 3000K 345LM	NS 21,19

Spot monobloc IP44



REFERENCE IMS	CODE FOURNISSEUR	DESIGNATION	HT €
D73A00006	50040	SPOT BIRDY BLANC LED 11W/4000K IP44	NS 35,72

● APPLIQUE SALLE DE BAIN - CUISINE

aric

CHOISIR SON APPLIQUE ET LE TUBE LED = REGLETTE LED



REFERENCE IMS	CODE FOURNISSEUR	DESIGNATION	HT €
7071120	1120	APPLIQUE TALASSO SIMPLE SANS TUBE	NS 12,74
IM052389	1121	APPLIQUE TALASSO INTER PROTEGE SANS TUBE	NS 14,34



REFERENCE IMS	CODE FOURNISSEUR	DESIGNATION	HT €
7071122	1122	APPLIQUE TALASSO INTER + PC SANS TUBE	NS 17,52

aric



REFERENCE IMS	CODE FOURNISSEUR	DESIGNATION	HT €
D73X00017	0312	APPLIQUE ONDINE SIMPLE 18W (SANS TUBE)	NS 71,25

● RUBAN LED

Vision-EL



REFERENCE IMS	CODE FOURNISSEUR	DESIGNATION	HT €
IM003417	9831	PROFILE LED PLAT 2000MM ANODISE*	NS 14,53

ECLAIRAGE EXTERIEUR

● PROJECTEUR

LEDVANCE



REFERENCE IMS	CODE FOURNISSEUR	DESIGNATION	HT €
IM014591	421011	PROJECTEUR LED 20W 4000K NOIR IP65	NS 33,75
IM009248	461031	PROJECTEUR LED 50W 4000K NOIR IP65 + DETECTEUR	NS 93,56
IM014592	422520	PROJECTEUR LED 80W (150W IOD) 4000K NOIR IP65	NS 159,38

ELECTRICITE

ECLAIRAGE EXTERIEUR ...

● PROJECTEUR ...



REFERENCE IMS	CODE FOURNISSEUR	DESIGNATION		HT €
IM169427	420908	PROJECTEUR LED 10W 4000K BLANC IP65	NS	23,62
IM169429	460973	PROJECTEUR LED 20W 4000K BLANC IP65 +DET	NS	50,57
IM169428	421288	PROJECTEUR LED 50W 4000K BLANC IP65	NS	54,25
IM169430	461055	PROJECTEUR LED 50W 4000K BLANC IP65 +DET	NS	87,32

LED SOLAIRE



REFERENCE IMS	CODE FOURNISSEUR	DESIGNATION		HT €
IM071233	1003474	APP SOLAIRE NOIRE LED 3,5W 3000K, IP54	NS	129,36

ECLAIRAGE FONCTIONNEL

● PLAFONNIER ENCASTRE



REFERENCE IMS	CODE FOURNISSEUR	DESIGNATION		HT €
7600055744	0055744	LUMINAIRE IVY 2 600X600 414/840 ENCASTRE	NS	78,91

● PLAFONNIER ETANCHE

EQUIVALENCE 1X36W



REFERENCE IMS	CODE FOURNISSEUR	DESIGNATION		HT €
IM056972	0046033	ETANCHE LED 1,2M 19W/840 2400LM IP65 SLI	NS	75,23

EQUIVALENCE 1X58W



REFERENCE IMS	CODE FOURNISSEUR	DESIGNATION		HT €
IM056973	0046034	ETANCHE LED 1,5M 28W/840 3700LM IP65 SLI	NS	63,63

COMMANDE D'ECLAIRAGE

● DETECTEUR THEBEN



DETECTEUR SAILLIE PLAFOND 360° IP40



REFERENCE IMS	CODE FOURNISSEUR	DESIGNATION		HT €
IM013726	1030022	DETECTEUR MOUVEMENTS PLAFOND 360° 1 CANAL	NS	63,53

DETECTEUR ENCASTRE PLAFOND 360° IP41



REFERENCE IMS	CODE FOURNISSEUR	DESIGNATION		HT €
IM007770	1030012	DETECTEUR MOUVEMENTS ENCASTRE PLAFOND 360°	NS	63,53

RADIATEUR THERMOR



● RADIATEUR CHALEUR DOUCE MOZART



REFERENCE IMS	CODE FOURNISSEUR	DESIGNATION		HT €
D03T00001	475211	RADIATEUR MOZART DIGITAL BLANC 500W	NS	300,71
D03T00002	475221	RADIATEUR MOZART DIGITAL BLANC 750W	NS	326,08
D03T00003	475231	RADIATEUR MOZART DIGITAL BLANC 1000W	NS	364,61
D03T00004	475241	RADIATEUR MOZART DIGITAL BLANC 1250W	NS	404,07
D03T00005	475251	RADIATEUR MOZART DIGITAL BLANC 1500W	NS	455,76
D03T00006	475271	RADIATEUR MOZART DIGITAL BLANC 2000W	NS	534,69



REFERENCE IMS	CODE FOURNISSEUR	DESIGNATION		HT €
D03T00026	475331	RADIATEUR MOZART DIGITAL VERTICAL BLANC 1000W	NS	408,77
D03T00027	475351	RADIATEUR MOZART DIGITAL VERTICAL BLANC 1500W	NS	514,96
D03T00028	475371	RADIATEUR MOZART DIGITAL VERTICAL BLANC 2000W	NS	604,23

● RADIATEUR CHALEUR DOUCE KENYA



REFERENCE IMS	CODE FOURNISSEUR	DESIGNATION		HT €
D03T00092	414521	KENYA 3 HORIZONTAL 750W	NS	488,68
D03T00093	414531	KENYA 3 HORIZONTAL 1000W	NS	541,67
D03T00095	414551	KENYA 3 HORIZONTAL 1500W	NS	662,37
D03T00096	414571	KENYA 3 HORIZONTAL 2000W	NS	809,56

RADIATEUR THERMOR ...

● SECHE-SERVIETTES CORSAIRE

DIMENSIONS (en mm)

ÉTROIT

Épaisseur : 100 mm

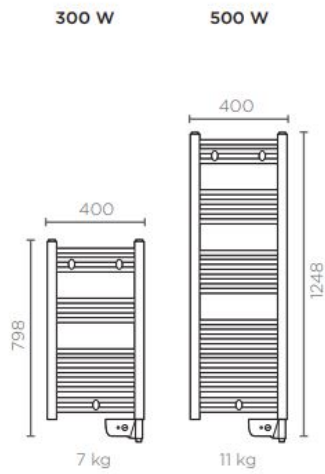

GALBÉ

Épaisseur : 100 mm

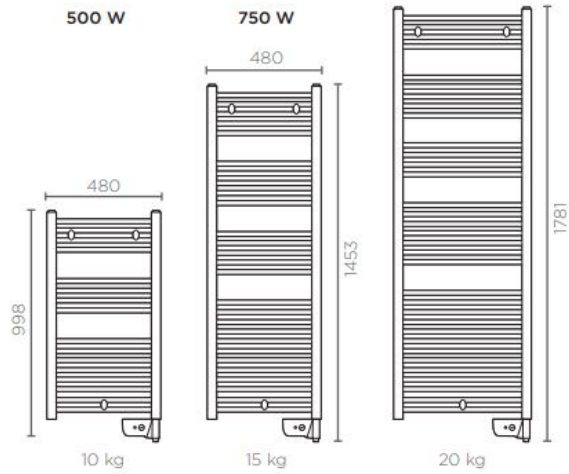

REFERENCE IMS	CODE FOURNISSEUR	DESIGNATION	HT €
D08T00022	473301	SECHE SERVIETTES CORSAIRE ETROIT 300W	NS 186,61
D08T00023	473311	SECHE SERVIETTES CORSAIRE ETROIT 500W	NS 210,56



REFERENCE IMS	CODE FOURNISSEUR	DESIGNATION	HT €
767472311	472311	SECHE SERVIETTES CORSAIRE 500W GALBE	NS 204,57
767472321	472321	SECHE SERVIETTES CORSAIRE 750W GALBE	NS 232,52
767472331	472331	SECHE SERVIETTES CORSAIRE 1000W GALBE	NS 268,44

● SECHE-SERVIETTES ALLURE MIXTE



REFERENCE IMS	CODE FOURNISSEUR	DESIGNATION	HT €
D08T00011	490361	SECHE SERVIETTES ALLURE DIGITAL MIXTE SOUFFLE 1750W	NS 952,02

● SECHE-SERVIETTES MAJORQUE



REFERENCE IMS	CODE FOURNISSEUR	DESIGNATION	HT €
D03T00142	493151	SECHE SERVIETTES MAJORQUE DIGITAL SOUFFLERIE BLANC 600W + 800W	440,60

ELECTRICITE

RADIATEUR THERMOR ...

- SECHE-SERVIETTES MAJORQUE ...



REFERENCE IMS	CODE FOURNISSEUR	DESIGNATION	HT €
D03T00141	493124	SECHE SERVIETTES MAJORQUE DIGITAL SOUFFLERIE GRIS ARDOISE 600W+800W	469,06



REFERENCE IMS	CODE FOURNISSEUR	DESIGNATION	HT €
D03T00070	400990	BRIDGE COZYTOUCH	NS 111,77



REFERENCE IMS	CODE FOURNISSEUR	DESIGNATION	HT €
D03T00071	450251	INTERFACE COZYTOUCH	46,90

RADIATEUR



REFERENCE IMS	CODE FOURNISSEUR	DESIGNATION	HT €
300TAKE050041	TAKE-050-041/CF	TAIGA TAKE ELECTRIQUE 500W BLANC	NS 460,92
IM006739	TAKE-075-049/CF	TAIGA TAKE ELECTRIQUE 750W BLANC	NS 498,57
300TAKE100051	TAKE-100-057/CF	TAIGA TAKE ELECTRIQUE 1000W BLANC	NS 475,03
IM003993	TAKE-125-073/CF	TAIGA TAKE ELECTRIQUE 1250W BLANC	NS 620,86
300TAKE150081	TAKE-150-081/CF	TAIGA TAKE ELECTRIQUE 1500W BLANC	NS 658,48
IM007618	TAKE-200-121/CF	TAIGA TAKE ELECTRIQUE 2000W BLANC	NS 837,22

DOMOTIQUE

- DELTA DORE



REFERENCE IMS	CODE FOURNISSEUR	DESIGNATION	HT €
IM004351	6351411	PACK VOLETS ROULANTS ET LAMPE D'APPOINT CONNECTES	NS 431,53

DOMOTIQUE YOKIS

- MINUTERIE



REFERENCE IMS	CODE FOURNISSEUR	DESIGNATION	HT €
7765454051	MTM500E	MINUTERIE ENCASTRE MTM500E	NS 49,32

ELECTRICITE

DOMOTIQUE YOKIS ...

● MINUTERIE ...



REFERENCE IMS	CODE FOURNISSEUR	DESIGNATION	HT €
7765454061	MTM500M	MINUTERIE MODULAIRE MTM500M	56,68

COFFRET DE COM

● ABB GRADE 3



REFERENCE IMS	CODE FOURNISSEUR	DESIGNATION	HT €
700215664	215664	COFFRET DE COMMUNICATION GALEO VDI GRADE 3 8RJ45 + TV	553,76

● SCHNEIDER GRADE 1



REFERENCE IMS	CODE FOURNISSEUR	DESIGNATION	HT €
D23S00091	VDIR390014	COFFRET DE COM. PACK GRD 1	125,89

● SCHNEIDER GRADE 2



REFERENCE IMS	CODE FOURNISSEUR	DESIGNATION	HT €
IM007564	VDIR390036	coffret Grade 2TV Box Essential - 6xRJ45 cat 6 + 4RJ45PTT + TV 3 SORTIES	369,74



REFERENCE IMS	CODE FOURNISSEUR	DESIGNATION	HT €
D23S00056	VDIB17726B01	CONNECTEUR RJ45 CAT 6 STP	12,84



REFERENCE IMS	CODE FOURNISSEUR	DESIGNATION	HT €
D23S00057	VDIR380005	SUPPORT RJ45 MODULAIRE VIDE	19,64

ELECTRICITE

COFFRET DE COM ...

- SCHNEIDER GRADE 2 ...



REFERENCE IMS	CODE FOURNISSEUR	DESIGNATION	HT €
D23S00055	VDIR326030	DTIO 2 TRAVERSEES SC-APC	67,15



REFERENCE IMS	CODE FOURNISSEUR	DESIGNATION	HT €
704VDIR547403	VDIR547403	CORDON INFO RJ45 / RJ45 1ML	NS 17,30



REFERENCE IMS	CODE FOURNISSEUR	DESIGNATION	HT €
704VDIR542110	VDIR542110	CORDON TELEPHONE RJ45-RJ11 2METRES VDIR542110	NS 10,00



REFERENCE IMS	CODE FOURNISSEUR	DESIGNATION	HT €
704VDIR541101	VDIR541101	CORDON TEL RJ11 30CM	NS 7,59

BOITE DE MACONNERIE SCHNEIDER

- MODULO BOITE DE CENTRE A SCELLER

ACCESSOIRE BOITIER PLACO / SCELLER



REFERENCE IMS	CODE FOURNISSEUR	DESIGNATION	HT €
704ALB71895	ALB71895	KIT ACCROCHAGE AUTOBLOQUANT	NS 10,03

BOITE D'ENCASTREMENT SCHNEIDER

- BOITIER PLACO CLOISON SECHE

BOITIER PLACO 32A



REFERENCE IMS	CODE FOURNISSEUR	DESIGNATION	HT €
704ALB71385	ALB71385	BOITE PLACO SIMPLE D85 P39	NS 5,00

ELECTRICITE

MAISON NEUVE KIT

● KIT SUR IMPOSITION



REFERENCE IMS	CODE FOURNISSEUR	DESIGNATION		HT €
IM050917	KA14A1V60Z2	KIT SUR IMPOSITION R-VOLT 1*300WC MONO = 300Wc	NS	1306,08
IM024294	KA14A2V60Z2	KIT SUR IMPOSITION R-VOLT 2*300WC MONO = 600Wc	NS	1643,25

IDEAL RENOVATION

● KIT SUR IMPOSITION



REFERENCE IMS	CODE FOURNISSEUR	DESIGNATION		HT €
IM052093	PK15A1L4V60Z2	KIT SUR IMPOSITION R-VOLT 4*300WC MONO = 1200Wc	NS	2480,98
IM052094	PK15A2L3V60Z2	KIT SUR IMPOSITION R-VOLT 6*300WC MONO = 1800Wc	NS	3520,13
IM024297	PK15A2L4V60Z2	KIT SUR IMPOSITION R-VOLT 8*300WC MONO = 2400Wc	NS	4618,47
IM052095	PK15A2L5V60Z2	KIT SUR IMPOSITION R-VOLT 10*300WC MONO = 3000Wc	NS	5712,39

ATTENTION

LES FRAIS DE PORT SONT INCLUS DANS LE PRIX DU KIT

ADDUCTION D'EAU

ACCESSOIRE

CONTROLE DE NIVEAU



REFERENCE IMS	CODE FOURNISSEUR	DESIGNATION		HT €
IM132899	451070	ROB. FLOTT. INOX E-FLOAT 1/2	NS	218,49

POMPE FIOUL



STATION 56/33
DIESEL
distributeur
de gas-oil
à usage privé

090003

Ensemble comprenant :

- Pompe PANTHER 56 mono 230 V.
- Volucompteur mécanique, 3 chiffres au journalier avec remise à zéro et 6 chiffres au totalisateur.
- Pistolet manuel.
- Tuyau Ø 20 mm. Longueur 4 m avec fil de masse.
- Avec clapet crépine 1" + 2 raccords tétine mâle 1" + colliers pour tuyau de Ø 20 mm.

Ensemble livré sans tuyau d'aspiration

REFERENCE IMS	CODE FOURNISSEUR	DESIGNATION		HT €
389090003	090003	STATION ST-56M.-K33 MONO 230V	NS	588,46

MASSAL

RESERVOIR HYDROPHORE GALVA



REFERENCE IMS	CODE FOURNISSEUR	DESIGNATION		HT €
IM233322	17051	RESERVOIR HYDROPHORE GALV SP500L 3,5B	NS	885,60

FOURNITURES GENERALES

ANTI-BELIER

- A RESSORT



REFERENCE IMS	CODE FOURNISSEUR	DESIGNATION		HT €
456186920	//1869-20	FEM 20/27	NS	26,11

ROBINET D'ARRET

- FM SANS PURGE



REFERENCE IMS	CODE FOURNISSEUR	DESIGNATION		HT €
34831161FM	B10312	15/21	NS	20,01

- MF SANS PURGE



REFERENCE IMS	CODE FOURNISSEUR	DESIGNATION		HT €
34831162	136558	20/27	NS	15,86

CUIVRE A SERTIR

- TE REDUIT FEM A SERTIR / MALE A VISSER



REFERENCE IMS	CODE FOURNISSEUR	DESIGNATION		HT €
565431EDE	P4132G01806018	18-20/27-18	NS	30,97
565431GDG	P4132G02206022	22-20/27-22	NS	37,18
565431HDH	P4132G02806028	28-20/27-28	NS	37,19

CUIVRE A SERTIR

- COUDE 90° FEMELLE FEMELLE



REFERENCE IMS	CODE FOURNISSEUR	DESIGNATION		HT €
IM024338	PG50020280000	D28	NS	8,43

MULTICOUCHE UPONOR

- COLLECTEUR UPONOR



REFERENCE IMS	CODE FOURNISSEUR	DESIGNATION		HT €
G44U00058	1014107	2 SORTIES		24,14

FONTE GALVA

- COUDE 90° GR FEMELLE FEMELLE



REFERENCE IMS	CODE FOURNISSEUR	DESIGNATION		HT €
303G00208	G00208	8/13	NS	2,47

FOURNITURES GENERALES

FORTE GALVA ...

● COUDE UNION 90° MALE FEMELLE



REFERENCE IMS	CODE FOURNISSEUR	DESIGNATION	HT €
303G09812	98G12	12/17	NS 6,14

● MAMELON MALE FEMELLE REDUIT



REFERENCE IMS	CODE FOURNISSEUR	DESIGNATION	HT €
303G2411512	241015012G	M15/21 - F12/17	NS 0,69
303G2418026		M80/90 - F26/34	NS 12,92
303G2418033		M80/90 - F33/42	NS 12,92

● MANCHON "DROITE GAUCHE"



REFERENCE IMS	CODE FOURNISSEUR	DESIGNATION	HT €
303G27112	271012G	12/17	NS 1,36
303G27115	271015G	15/21	NS 1,22
303G27140	271040G	40/49	NS 4,41
303G27150	271050G	50/60	NS 7,84

● MANCHON TARAUDAGE DROITE



REFERENCE IMS	CODE FOURNISSEUR	DESIGNATION	HT €
303G227012	2701012G	12/17	NS 0,95
303G227040	2701040G	40/49	NS 3,50

● MANCHON REDUIT FEMELLE



REFERENCE IMS	CODE FOURNISSEUR	DESIGNATION	HT €
303G2401512		15/12 - 12/17	NS 1,27
303G2402012		20/27 - 12/17	NS 1,79
303G2402015	240020015G	20/27 - 15/21	NS 1,38
303G2402620	240026020G	26/34 - 20/27	NS 1,58
303G2404015		40/49 - 15/21	NS 5,59

● TE FEMELLE



REFERENCE IMS	CODE FOURNISSEUR	DESIGNATION	HT €
303G13066	130066G	66/76	NS 20,47

FORTE NOIRE

● COUDE 45° GR FEMELLE FEMELLE



REFERENCE IMS	CODE FOURNISSEUR	DESIGNATION	HT €
303N0412027	041020N	20/27	NS 2,61

● COUDE 45° GR MALE FEMELLE



REFERENCE IMS	CODE FOURNISSEUR	DESIGNATION	HT €
303N04015	040015N	15/21	NS 1,74

FOURNITURES GENERALES

FRONT NOIR ...

● COUDE 90° GR FEMELLE FEMELLE



REFERENCE IMS	CODE FOURNISSEUR	DESIGNATION		HT €
303N00212	002012N	12/17	NS	1,64
303N00215	002015N	15/21	NS	1,74
303N00266	002066N	66/76	NS	29,83

● COUDE UNION FEMELLE FEMELLE



REFERENCE IMS	CODE FOURNISSEUR	DESIGNATION		HT €
303N09612	096012N	12/17	NS	5,02

● COUDE UNION MALE FEMELLE



REFERENCE IMS	CODE FOURNISSEUR	DESIGNATION		HT €
303N09812		12/17	NS	4,96

● MAMELON MALE FEMELLE REDUIT



REFERENCE IMS	CODE FOURNISSEUR	DESIGNATION		HT €
303N2414012	241040012N	M40/49 - F12/17	NS	2,85
303N2415015	241050015N	M50/60 - F15/21	NS	3,73

● MAMELON MALE MALE REDUIT



REFERENCE IMS	CODE FOURNISSEUR	DESIGNATION		HT €
303N2454020	245040020N	40/49 - 20/27	NS	2,99

● MANCHON FEMELLE FEMELLE REDUIT



REFERENCE IMS	CODE FOURNISSEUR	DESIGNATION		HT €
303N2402615	240026015N	26/34 - 15/21	NS	1,40

● TE REDUIT FEMELLE



REFERENCE IMS	CODE FOURNISSEUR	DESIGNATION		HT €
303N1302620	130026020026N	26/34-20/27-26/34	NS	1,65

RACCORD A COMPRESSION

● COUDE FEMELLE



REFERENCE IMS	CODE FOURNISSEUR	DESIGNATION		HT €
45637256350	UCT632	50/60-63	NS	12,55

FOURNITURES GENERALES

RACCORD A COMPRESSION PLASTIQUE ...

● COUDE EGAL



REFERENCE IMS	CODE FOURNISSEUR	DESIGNATION	HT €
456372263	UC63	63 NS	15,02

● BOUCHON



REFERENCE IMS	CODE FOURNISSEUR	DESIGNATION	HT €
456373850	UB50	D50 NS	6,16

RACCORD RAPIDE (TYPE TECTITE)

● TE EGAL



REFERENCE IMS	CODE FOURNISSEUR	DESIGNATION	HT €
IM006797	T13012	12 NS	11,50

● MANCHON FEMELLE A VISSER



REFERENCE IMS	CODE FOURNISSEUR	DESIGNATION	HT €
IM006801	T270G1212	12-1/2 NS	11,02

● OUTILLAGE DEMONTAGE TECTITE



REFERENCE IMS	CODE FOURNISSEUR	DESIGNATION	HT €
IM006805	40512	CLIP 12 NS	2,38
IM006806	40514	CLIP 14 NS	2,38



REFERENCE IMS	CODE FOURNISSEUR	DESIGNATION	HT €
IM006803	30512	PINCE 12 NS	10,65



REFERENCE IMS	CODE FOURNISSEUR	DESIGNATION	HT €
IM006807	05053554	CLE 35-54 NS	27,48



REFERENCE IMS	CODE FOURNISSEUR	DESIGNATION	HT €
IM006808	044179	INSERT PER 12 NS	0,19

PVC EVACUATION GRIS

● MANCHON DE DILAT MF PR CANALISATION HORIZ



REFERENCE IMS	CODE FOURNISSEUR	DESIGNATION	HT €
407MPH	MPH	D75 NS	20,43

● CULOTTE CHUTUNIC



REFERENCE IMS	CODE FOURNISSEUR	DESIGNATION	HT €
407RAM11	RAM11	PARAL 67°30 D100 NS	58,83

FOURNITURES GENERALES

PVC PRESSION

- TE EGAL FF

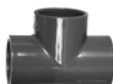

REFERENCE IMS	CODE FOURNISSEUR	DESIGNATION	HT €
332583075	T9075	FF 75	NS 6,75

COLLECTEUR SANITAIRE

- NOURRICE MM 3/4 SORTIES 1/2



REFERENCE IMS	CODE FOURNISSEUR	DESIGNATION	HT €
G39X00007	2930500	MM 20/27 - 2+1 SORTIES 15/21	NS 5,04

ACIER

- NOIR BOUT LISSE SANS SOUDURE TARIF 3



REFERENCE IMS	CODE FOURNISSEUR	DESIGNATION	HT €
325NT34049	3678469	40/49	NS 9,19

PRODUIT DE SCHELLEMENT



REFERENCE IMS	CODE FOURNISSEUR	DESIGNATION	HT €
G88X00007	63515	CARTOUCHE SCHELLEMENT CHIMIQUE 170 ML	NS 13,39

JOINT

- TORIQUE



REFERENCE IMS	CODE FOURNISSEUR	DESIGNATION	HT €
3761818048	181804	7 DIM. 8,9X1,9X12,7 x20	NS 0,19

- CLAPET PERCE

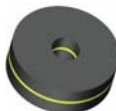

REFERENCE IMS	CODE FOURNISSEUR	DESIGNATION	HT €
3765911035	591103	CHAFFEAUTEAUX 4X16X4 x25	NS 0,33

- CLAPET PLEIN NEOPAN EPDM



REFERENCE IMS	CODE FOURNISSEUR	DESIGNATION	HT €
3765012039	501203	FILET JAUNE N°6 x25	NS 0,23

FOURNITURES GENERALES

JOINT ...

- CLAPET PLEIN NEOPAN EPDM ...



REFERENCE IMS	CODE FOURNISSEUR	DESIGNATION	HT €
3763109007	23013748	45X70X6 x1 NS	1,18

- CONE



REFERENCE IMS	CODE FOURNISSEUR	DESIGNATION	HT €
3764011002	998813	CONE WC GRAND MODELE 2306-B 30X65 x1	4,45

PEINTURE ET TRACAGE

- GALVANISANT



REFERENCE IMS	CODE FOURNISSEUR	DESIGNATION	HT €
368814163	814163	PEINTURE ALUMINIUM AEROSOL 500ML NS	23,82

CHEVILLE

- CHEVILLE METAL A EXPANSION (SANS VIS)



REFERENCE IMS	CODE FOURNISSEUR	DESIGNATION	HT €
IM166440	26240	08X55 NS	27,79

FIXATION SANITAIRE

- CONSOLE LAVABO



REFERENCE IMS	CODE FOURNISSEUR	DESIGNATION	HT €
597D5706AC	D5706AC	LG25CM - X2	35,10

VISSERIE ET BOULONNERIE

- VIS BOIS TORX TETE FRAISEE GRDE LONGUEUR



REFERENCE IMS	CODE FOURNISSEUR	DESIGNATION	HT €
IM018840	53040/8	8X120 BTE 50	18,69

FOURNITURES GENERALES

VISSERIE ET BOULONNERIE ...

● VIS METAUX TETE HEXA ACIER



REFERENCE IMS	CODE FOURNISSEUR	DESIGNATION	HT €
IM018845	03742/6	M6X35 BTE 200	15,67

● VIS PENTURE TORX



REFERENCE IMS	CODE FOURNISSEUR	DESIGNATION	HT €
IM018842	08812/1	6X30 BTE 100	7,97
004288268	OR00614389	6X50 BTE 200	17,98
J01X00037	288282	7X50 BTE 200	34,30

● ECROU



REFERENCE IMS	CODE FOURNISSEUR	DESIGNATION	HT €
IM221066	576016 PAR 1000	HEXAG ZINGUE M6	20,12

● RONDELLE



REFERENCE IMS	CODE FOURNISSEUR	DESIGNATION	HT €
IM219999	568008 X1000	ZINGUEE M6 14	9,00

OUTILLAGE

MILWAUKEE

- PERCEUSE A BATTERIE



REFERENCE IMS	CODE FOURNISSEUR	DESIGNATION	HT €
IM053817	4933451430	PERFORATEUR SDS+ 18V 11J 12Ah SANS BATTERIE	NS 453,32

ABRASIF ET DISQUE

- DISQUE D PRO-CERAMIC



REFERENCE IMS	CODE FOURNISSEUR	DESIGNATION	HT €
4372608615020	2608615020	ø 76 MM	NS 19,71

- SCIE TREPAN MULTICONSTRUCTION



REFERENCE IMS	CODE FOURNISSEUR	DESIGNATION	HT €
4372608584763	2608584763	ø 68 MM	NS 63,06

FORET BETON (MARTEAU) SDS

- FORET BETON SDS MAX



REFERENCE IMS	CODE FOURNISSEUR	DESIGNATION	HT €
4372608586771	2608586771	22X400X520	NS 85,35
4372608586773	2608586773	22X800X920	NS 128,42

- COFFRET DE 10 FORETS LAMINES HSS-R



REFERENCE IMS	CODE FOURNISSEUR	DESIGNATION	HT €
4371609200203	2608577348	SET	NS 20,88

ACCESSOIRE GOP (MULTIFONCTION)

- LAME PLONGEANTE METAL



REFERENCE IMS	CODE FOURNISSEUR	DESIGNATION	HT €
K45B00017	2608662019	HM 20X30	NS 20,78

OUTILLAGE

OUTILLAGE

● TRUELLE A JOINT PLATE



REFERENCE IMS	CODE FOURNISSEUR	DESIGNATION		HT €
3931440237	144.0237	LAME ACIER 10MM	NS	8,26

● CRAYON DE CHARPENTIER



REFERENCE IMS	CODE FOURNISSEUR	DESIGNATION		HT €
3933000070	300.0070	LA PIECE L.250MM	NS	1,36

● COUPE-GAINE ROCUT DE 0 A 32MM



REFERENCE IMS	CODE FOURNISSEUR	DESIGNATION		HT €
K01R00022	21500	LA PIECE	NS	35,28

● BARRE DE MONTAGE 18MM



REFERENCE IMS	CODE FOURNISSEUR	DESIGNATION		HT €
3931320800	132.0800	1"-750MM	NS	39,66

● RESSORT A CINTRER



REFERENCE IMS	CODE FOURNISSEUR	DESIGNATION		HT €
43525182	25182	10	NS	31,57

OUTILLAGE

OUTILLAGE ELECTRICIEN

- PINCE A SERTIR A CLIQUET POUR COSSES 10-25MM2



REFERENCE IMS	CODE FOURNISSEUR	DESIGNATION	HT €
470430022	430022	LA PIECE	NS 91,41

PROTECTION HYGIÈNE

- GANT



REFERENCE IMS	CODE FOURNISSEUR	DESIGNATION	HT €
IM060005	G085-D100-T8	PAIRE GANTS ANTI-COUPURE T8	NS 3,77
K45X00028	8197/9	PAIRE GANTS T9 CHLOROPRENE	NS 4,31

ENTRETIEN DES SURFACES

- LAVETTE MICROCLASSIC EVOLUTION 30X40CM



REFERENCE IMS	CODE FOURNISSEUR	DESIGNATION	HT €
K45X00038	105922	PAR 5	NS 21,09

- PAIRE DE BOTTES PU VERT



REFERENCE IMS	CODE FOURNISSEUR	DESIGNATION	HT €
IM014860	00010-040 T42	T42	NS 58,70
IM014861	00010-040 T44	T44	NS 58,70

CARRELAGE

PRODUIT DE MISE EN OEUVRE

- LES CLASSIQUES GRIS



REFERENCE IMS	CODE FOURNISSEUR	DESIGNATION		HT €
IM000859	COLJF5_G	JOINT PRB FIN GRIS 5 KG PRB CLASSE CG2	NS	6,02



REFERENCE IMS	CODE FOURNISSEUR	DESIGNATION		HT €
IM074714	11101729	JOINT WEBER DESIGN T06 ARGILE 5KG	NS	31,33

PROFILE

- CHANT 1/4 DE ROND



REFERENCE IMS	CODE FOURNISSEUR	DESIGNATION		HT €
IM021206	E/PRO100BW	ANGLE SORTANT 90° RONDEC PRO EP 10MM PVC BLANC	NS	1,67

NATTE



REFERENCE IMS	CODE FOURNISSEUR	DESIGNATION		HT €
IM000754	5569244	NATTE PRB CERAMIC EPI/SPEC 1X30ML NATTE PRB ETANCHEITE	NS	441,55

CONSOMMABLE

- ACCESSOIRE DE POSE



REFERENCE IMS	CODE FOURNISSEUR	DESIGNATION		HT €
IM012180	71897	MAILLET MANCHE BOIS 1000 GR	NS	17,13

CARRELAGE

CONSOMMABLE ...

- ACCESSOIRE DE POSE ...



REFERENCE IMS	CODE FOURNISSEUR	DESIGNATION		HT €
IM195501	SEAUDOS	SEAU DOSEUR CARRELEUR 12 L	NS	4,69

NETTOYAGE ET PROTECTION



REFERENCE IMS	CODE FOURNISSEUR	DESIGNATION		HT €
IM055205	60400012	DETERDEK 1 LT FILA DECAPANT FIN DE CHANTIER	NS	12,81
IM055206	60400003	DETERDEK 5 LT FILA DECAPANT FIN DE CHANTIER	NS	45,80

CARREAU DE SOL INTERIEUR - IMITATION BOIS



- 20X120



REFERENCE IMS	CODE FOURNISSEUR	DESIGNATION		HT €
IM074119	8435592007663	CX 20X120 SELANDIA MIELE RECTIFIE 8435592007663	NS	27,66



- 20X40



REFERENCE IMS	CODE FOURNISSEUR	DESIGNATION		HT €
IM016198	WAKV4104	FAIENCE 30X60 BLANC MAT RECT	NS	26,38

SAINT-DIDIER (35) - SIÈGE SOCIAL

ZA ARTIPÔLE
35220 SAINT DIDIER

Tél. 02 99 00 92 28

Lundi au vendredi : 9h - 12h et 13h30 - 18h
Samedi : 9h - 12h30 et 13h30 - 18h



ST MALO (35)

5 rue du Docteur Alain Lefort
35400 ST MALO

Ouverture en 2023



PLÉRIN (22)

39 rue de la ville Crohen
22190 PLÉRIN

Tél. 02 96 58 62 05

Lundi au vendredi : 9h - 12h et 13h30 - 18h
Samedi : 9h - 12h30 et 13h30 - 18h



MARTIGNÉ-SUR-MAYENNE (53)

ZA LE BERRY
53470 MARTIGNÉ-SUR-MAYENNE

Tél. 02 43 49 07 68

Lundi au vendredi : 9h - 12h et 13h30 - 18h
Samedi : 9h - 12h30 et 13h30 - 18h



Rendez-vous sur l'extranet
ADHERENTS.IMS.COOP
N'hésitez pas à NOUS contacter !