

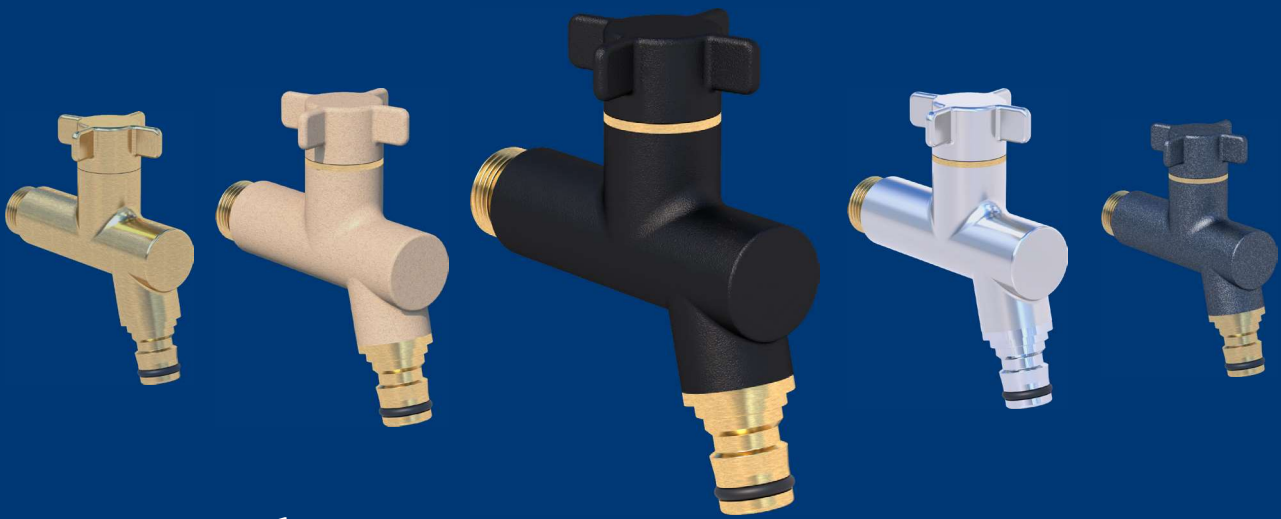

OSLO

FIXATIONS & ROBINETTERIE D'EXTERIEUR



1 ROBINET D'EXTÉRIEUR

5 SOLUTIONS D'INSTALLATION

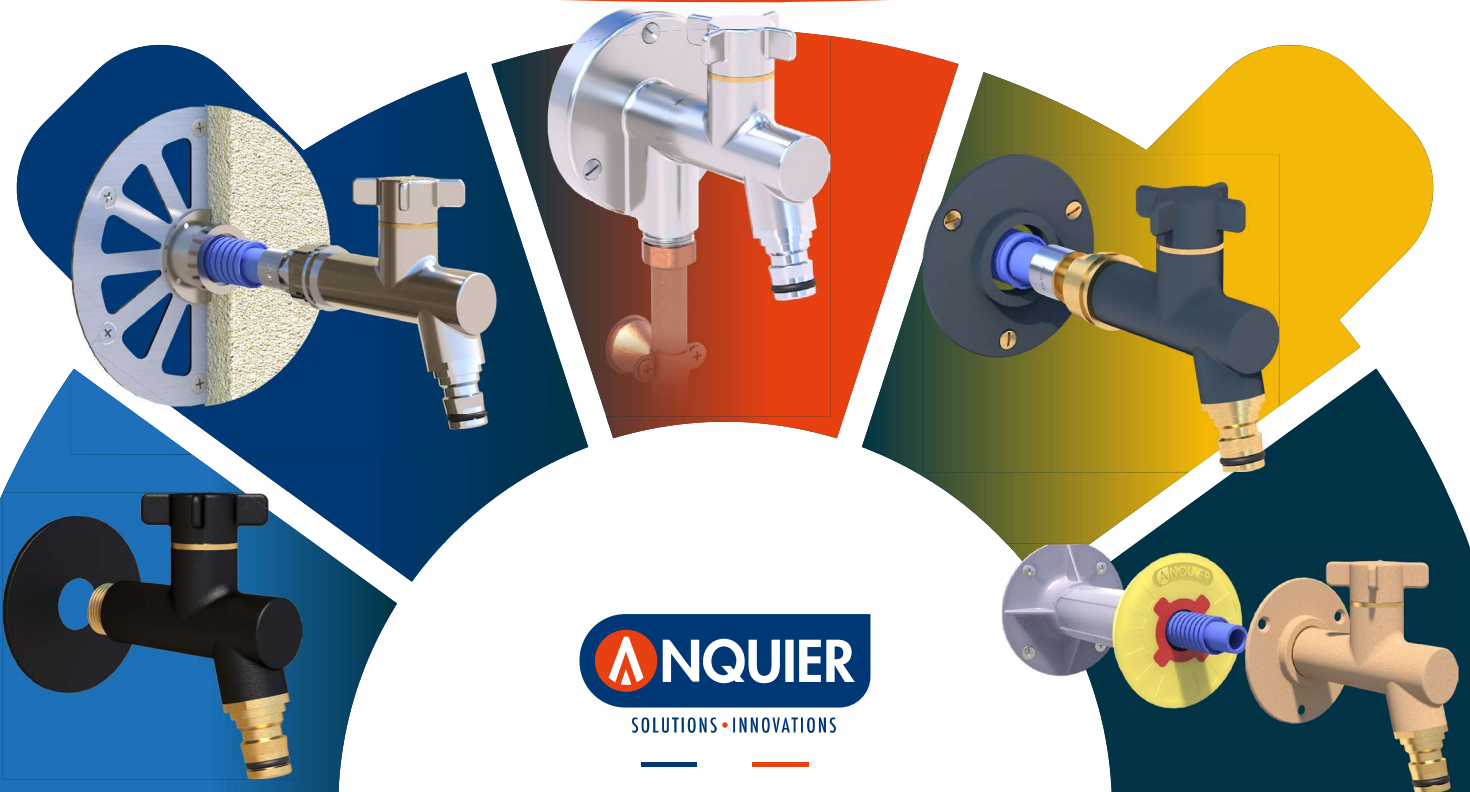

ANQUIER
SOLUTIONS • INNOVATIONS

OSLO

LE ROBINET D'EXTÉRIEUR



OUVERTURE RAPIDE

Débit maxi : 50 l/mn dès 1/4 tour



LONGÉVITÉ MAXIMISÉE

Déplacement vertical du clapet de fermeture

M $\frac{1}{2}$



ROBINET PROTÉGÉ DU GEL

Absorption de la variation de la masse volumique par une cartouche compressible



RACCORD AU NEZ À CONNEXION RAPIDE DÉMONTABLE

S'adapte à tous types de connectique automatique standard



VERTICAL

LAITON



VLA

NICKEL



VNI

MANGANÈSE



VMA

ANTHRACITE



VAN

SABLE

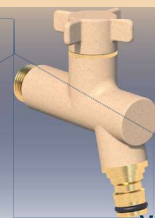

VSA

NOIR



VNO

HORIZONTAL

LAITON



HLA

NICKEL



HNI

MANGANÈSE

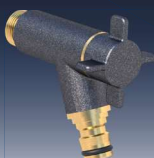

HMA

ANTHRACITE

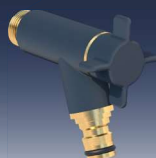

HAN

SABLE

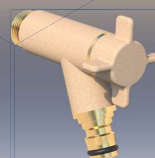

HSA

NOIR



HNO

APLIC À VISSER POUR RACCORDEMENT CUIVRE



ALIGNEMENT PARFAIT
Avec et sans réhausse

Gamme d'appliches à visser arrivée M $\frac{1}{2}$ " pour raccordement tube cuivre protégées du gel.
LIVRÉE AVEC : RÉHAUSSE permettant un alignement parfait avec la canalisation d'arrivée.



ROSACE DE FINITION (Ø M $\frac{1}{2}$ ") POUR RACCORDEMENT À VISSER

Gamme de rosaces de finition **ÉPAISSEUR 3 MM** permettant un montage par simple pincement entre le robinet et le mur d'installation.

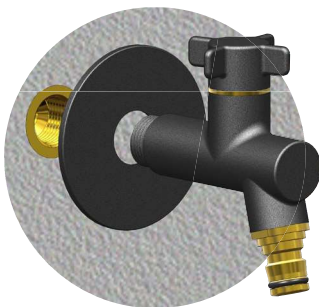

Déformation possible de la rosace de 2 mm maxi par compression lors du vissage du robinet.

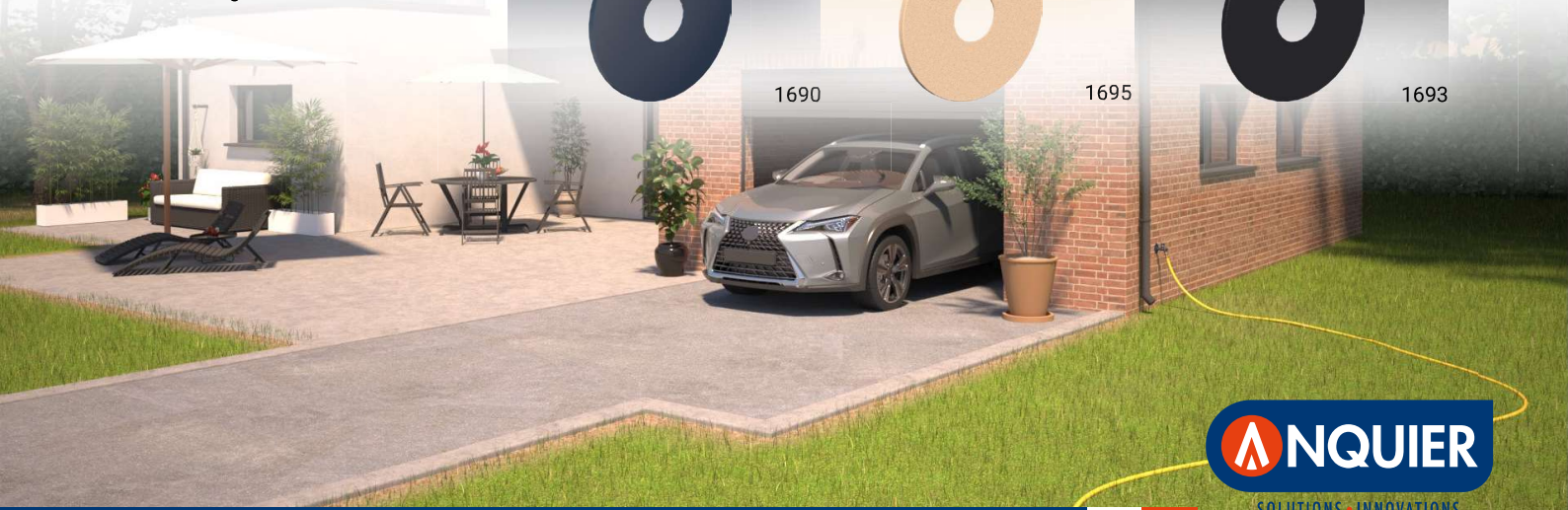

SOLO

APLIC'EASY

FIXATION EN TRAVERSÉE DE CLOISON

GAMME DE RACCORDEMENTS

	À GLISSEMENT	À SERTIR	À VISSER	À SOUDER	MULTICOUCHE /U-H-TH		
							
	12	16	12	16	F $\frac{1}{2}$ "	14&16	16x2
	1650	1651	1652	1653	1654	1655	1656
	1670	1671	1672	1673	1674	1675	1676
	GL12NI	GL16NI	ST12NI	ST16NI	F12NI	CUNI	M16NI
	GL12MA	GL16MA	ST12MA	ST16MA	F12MA	CUMA	M16MA
	GL12AN	GL16AN	ST12AN	ST16AN	F12AN	CUAN	M16AN
	GL12SA	GL16SA	ST12SA	ST16SA	F12SA	CUSA	M16SA
	GL12NO	GL16NO	ST12NO	ST16NO	F12NO	CUNO	M16NO

LES AVANTAGES

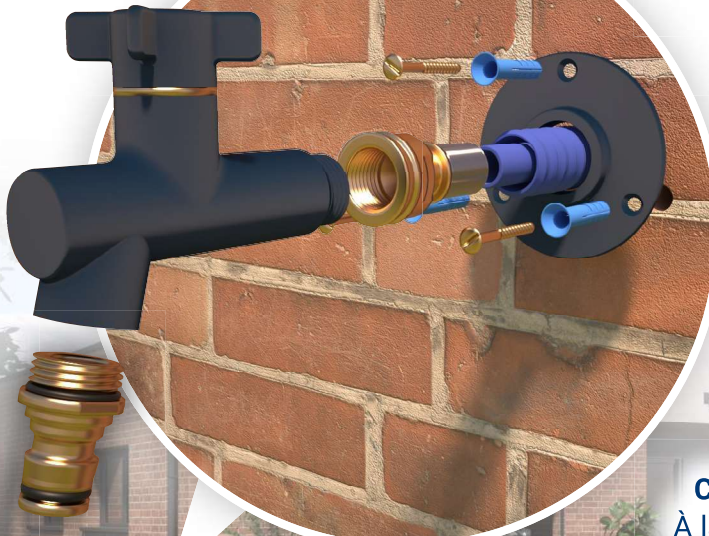

APPLIQUE Ø 85 mm

Pour une fixation aisée et fiable

POUR ROBINET EN ARRIVÉE M $\frac{1}{2}$ "

Permet la pose de tout type de robinet

POSITIONNEMENT DU ROBINET

Facile et sans contrainte

DÉMONTABLE

Connexion visitable après pose

CONFORME

À la norme RT 2012

KIT

APLIC'EASY

FIXATION EN TRAVERSÉE DE CLOISON

GAMME DE RACCORDEMENTS

À GLISSEMENT

À SERTIR

À VISSER

À SOUDER

MULTICOUCHE / U-H-TH

APLIC'EASY
BREVETÉ

		LAITON	NICKEL	MANGANÈSE	ANTHRACITE	SABLE	NOIR
							
KIT VERTICAL	12	VGL12LA	VGL12NI	VGL12MA	VGL12AN	VGL12SA	VGL12NO
	16	VGL16LA	VGL16NI	VGL16MA	VGL16AN	VGL16SA	VGL16NO
	12	VST12LA	VST12NI	VST12MA	VST12AN	VST12SA	VST12NO
	16	VST16LA	VST16NI	VST16MA	VST16AN	VST16SA	VST16NO
	F½"	VF12LA	VF12NI	VF12MA	VF12AN	VF12SA	VF12NO
	14&16	VCULA	VCUNI	VCUMA	VCUAN	VCUSA	VCUNO
	16x2	VM16LA	VM16NI	VM16MA	VM16AN	VM16SA	VM16NO

APLIC'EASY
BREVETÉ

		LAITON	NICKEL	MANGANÈSE	ANTHRACITE	SABLE	NOIR
							
KIT HORIZONTAL	12	HGL12LA	HGL12NI	HGL12MA	HGL12AN	HGL12SA	HGL12NO
	16	HGL16LA	HGL16NI	HGL16MA	HGL16AN	HGL16SA	HGL16NO
	12	HST12LA	HST12NI	HST12MA	HST12AN	HST12SA	HST12NO
	16	HST16LA	HST16NI	HST16MA	HST16AN	HST16SA	HST16NO
	F½"	HF12LA	HF12NI	HF12MA	HF12AN	HF12SA	HF12NO
	14&16	HCULA	HCUNI	HCUMA	HCUAN	HCUSA	HCUNO
	16x2	HM16LA	HM16NI	HM16MA	HM16AN	HM16SA	HM16NO

ANQUIER

SOLUTIONS - INNOVATIONS

Sachet cavalier  Blibox 

SOLO

APLIC'ENDUIT

FIXATION PAR NOYAGE DANS UN MUR ENDUIT

GAMME DE RACCORDEMENTS

À GLISSEMENT

À SERTIR

À VISSER

À SOUDER

MULTICOUCHE /U-H-TH

APLIC'ENDUIT
BREVETÉ

LAITON

NICKEL

MANGANÈSE

ANTHRACITE

SABLE

NOIR



12

1660

1680

1690

1700

1710

1720

16

1661

1681

1691

1701

1711

1721

12

1662

1682

1692

1702

1712

1722

16

1663

1683

1693

1703

1713

1723

F $\frac{1}{2}$ "

1664

1684

1694

1704

1714

1724

14&16

1665

1685

1695

1705

1715

1725

16x2

1666

1686

1696

1706

1716

1726

MONTAGE



GRILLE SUPPORT Ø 175 mm

Pour une fixation rigide et fiable



POUR ROBINET EN ARRIVÉE M $\frac{1}{2}$ "

Permet la pose de tout type de robinet



POSITIONNEMENT DU ROBINET

Facile et sans contrainte

DÉMONTABLE

Connexion visible après pose

CONFORME

À la norme RT 2012

CONCEPT

TEfix PERMET :

- ▶ La fixation sécurisée d'une robinetterie ou d'appareillage électrique ou électronique.
- ▶ Le passage (grâce au pied support) de la canalisation associée noyée 1 ou pas 2 au sein d'une ITE.

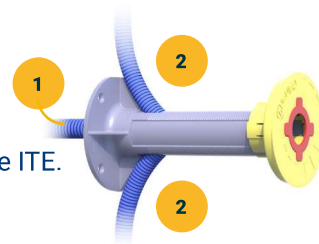

APPLICATION 1 ROBINET D'EXTÉRIEUR

Assure le raccordement et la fixation d'une robinetterie d'extérieur. Idéalement conçu pour le montage d'**APLIC'EASY**, il est néanmoins possible de l'utiliser pour fixer tous types d'appeliques du commerce.

Longueur ajustable de 70 à 210 mm
(Système de crantages au pas de 2.5 mm.)

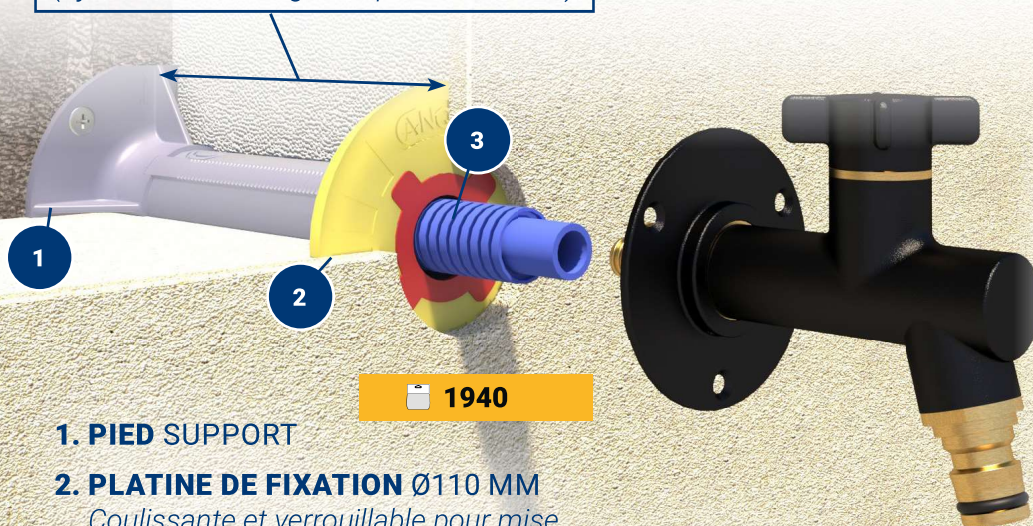

1. PIED SUPPORT

2. PLATINE DE FIXATION Ø110 MM

Coulissante et verrouillable pour mise à longueur. Fixation de l'appelique par vis de Ø mini : 3.5 mm

3. VEROU DE POSITIONNEMENT

1940

LES CARACTÉRISTIQUES ESSENTIELLES DE NOS TEfix

- ▶ Le **diamètre de passage** du raccordement *Maxi* : Ø40 mm
- ▶ La **masse de l'objet** à fixer *Maxi* : 4 Kg
- ▶ L'**efficacité de l'étanchéité** thermique du canal

TOUS NOS TEfix SONT LIVRÉS AVEC :

- ▶ Un manchon isolant (ext. : Ø40 mm ; int. : Ø22 mm ; long : 200 mm) pour protection pont thermique (RT 2012)

APPLICATION 2 PRISE ÉLECTRIQUE ÉTANCHE

Assure le raccordement et la fixation (4 vis Ø 3 mm) d'une prise électrique étanche. Boîtier d'encastrement pour appareillage électrique standard.

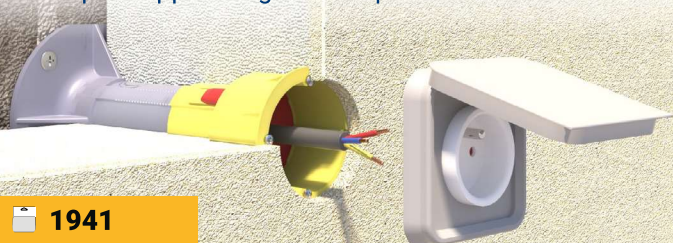

1941

APPLICATION 3 ALARME, CAMÉRA, ÉCLAIRAGE...

Platine Ø 110 mm assurant le raccordement et la fixation par vis de Ø 3.5 mini d'un spot lumineux, d'un pied de caméra... ou le passage de toutes canalisations (fibre...).



1942

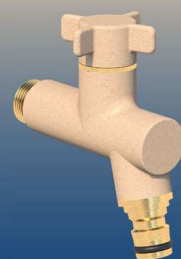

OSLO

FIXATIONS & ROBINETTERIE D'EXTÉRIEUR

LAITON

NICKEL

MANGANÈSE

ANTHRACITE

SABLE

NOIR

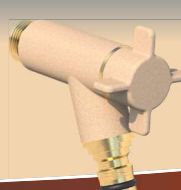

100 % COMPATIBLE

APLIC'EASY

EN TRAVERSÉE
DE CLOISON

APLIC'ENDUIT

EN NOYAGE
SUR MUR ENDUIT

TEfix

EN PRÉSENCE
D'ISOLATION THERMIQUE

EN VIDÉO



CONNEXION RAPIDE



OUVERTURE RAPIDE



PROTÉGÉ DU GEL



909, route de Vaudricourt
80130 BOURSEVILLE

03.22.30.24.28
www.anquier.fr

