

INSTALAÇÃO

INSTALACIÓN

INSTALLATION

01

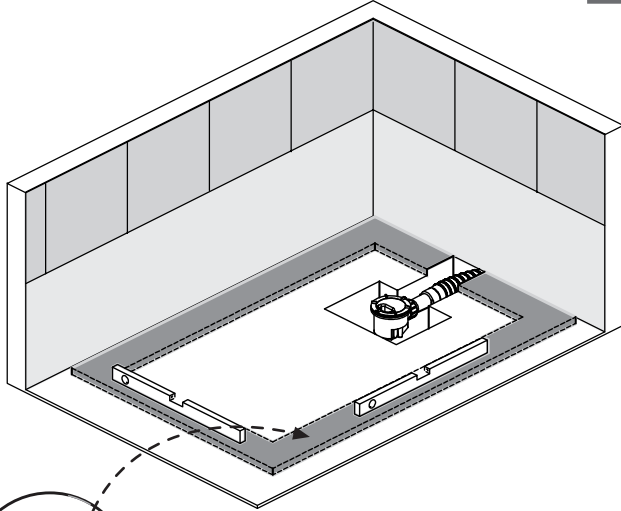

Betão
Hormigon
Concrete
Béton

24 h

02

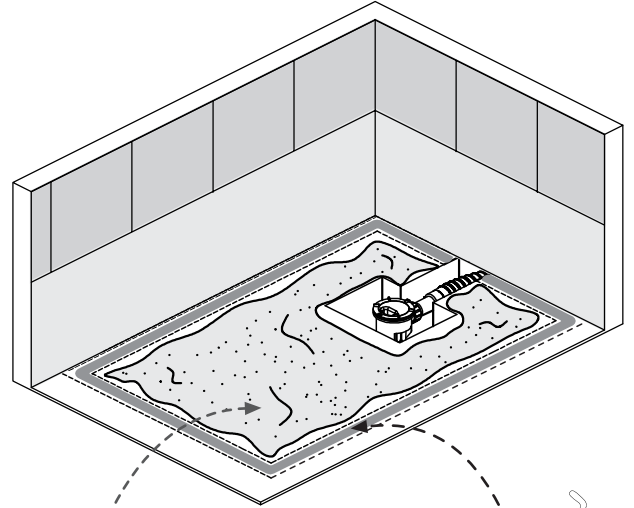

> 90%
Areia
Arena
Sand
Sable

< 10%
Cal
Lime
Chaux

Mastic / Silicone
Mastic / Silicona

03

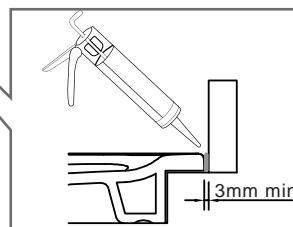
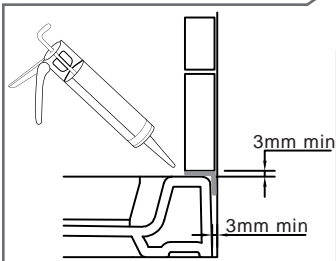
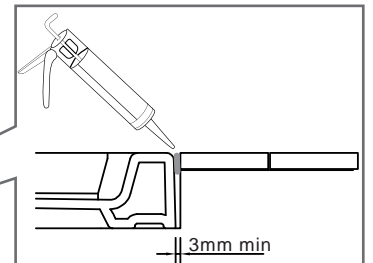
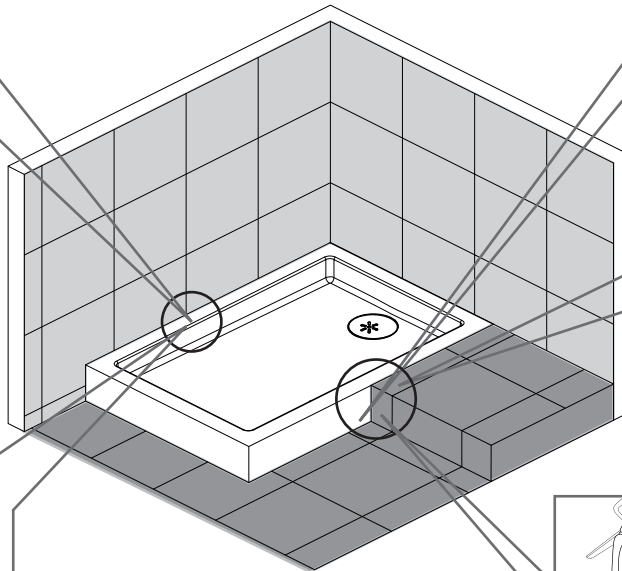
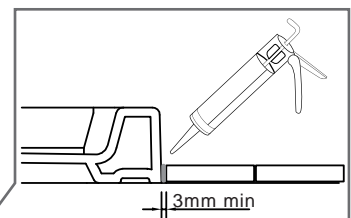
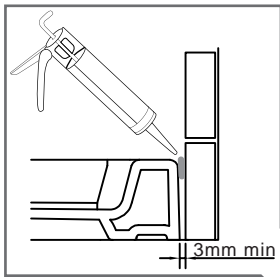

04

24 h