

Contenu / Inhalt / Contenido / Contents / Contenuto

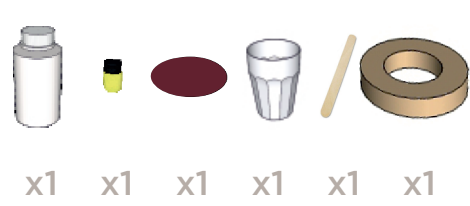

1 papier à poncer + 1 verre + 1 spatule + 2 bouteilles (résine, catalyseur) + 13m ruban adhésif
 1 Sandpapier + 1 Glas + 1 Spacel + 2 Flaschen (Harhtz, ataly Ksator) + 13m Abdeckkleband
 1 papel de lija + 1 vaso + 1 espátula + 2 botellas (resina, catalizador) + 13m cinta de pintor
 1 sandpaper + 1 glass + 1 palette knife + 2 bottles (resin, catalyst) + 13m masking tape
 1 carta smerigliata+ 1 vasetto+1 spatola+ 2 bottiglie (resina, catalizzatore) + 13m nastro per mascheratura

Mode d'emploi / Anwendungsvorschriften / Modo de empleo / Use manual / Istruzioni



Le produit doit rester sec pendant les 24 heures précédant l'intervention/ Die Duschwanne muß 24 Stunden vor der Reparatur trocken bleiben/ No humedecer el plato en las 24h previas/ Keep the product dry 24 hours prior to the intervention/ Non bagnare il piatto nelle 24 ore precedenti

KIT F.- KIT DE RÉPARATION DE MASSE / KIT REPARATURMASSE / KIT DE REPARACIÓN DE MASA / FIXING KIT / KIT DI REPARAZIONE DI MASSA

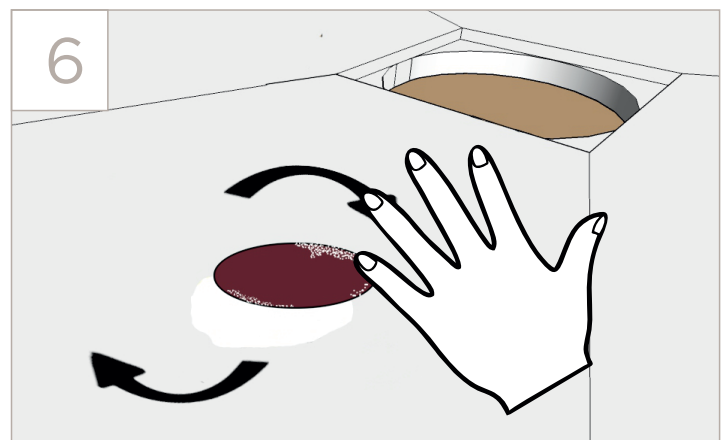
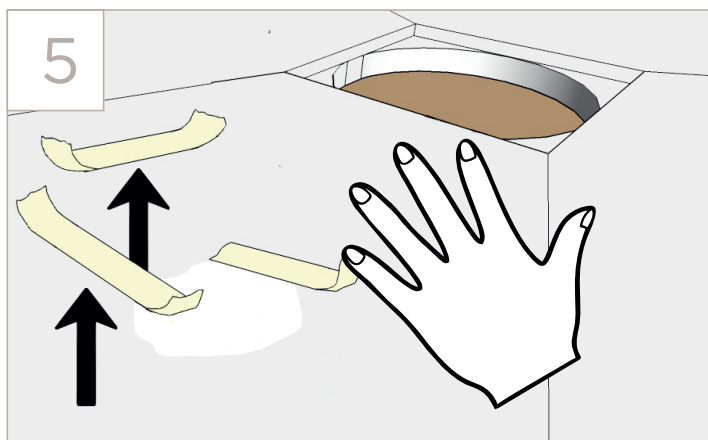
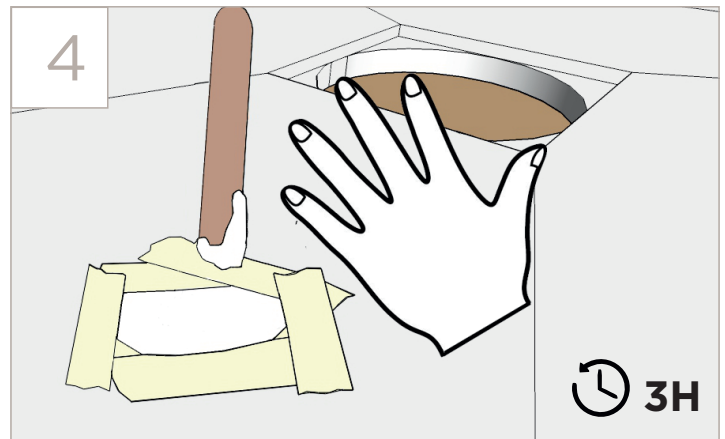
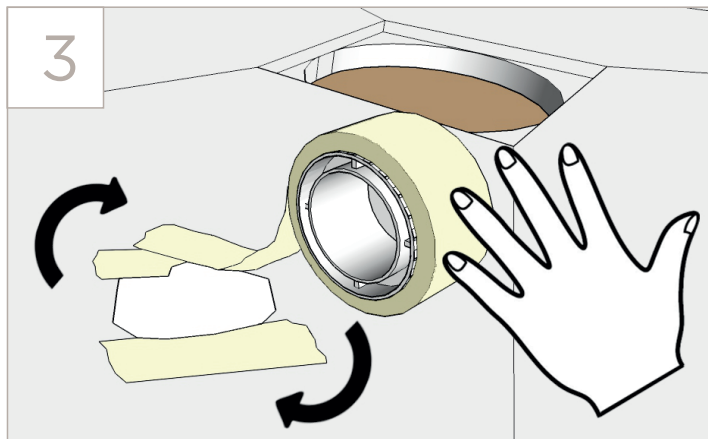
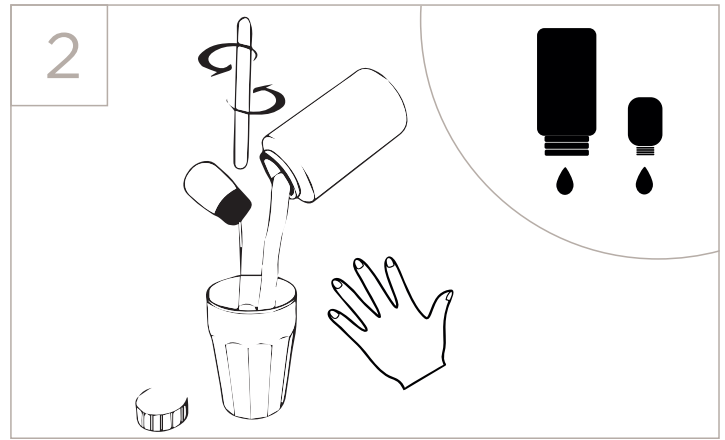
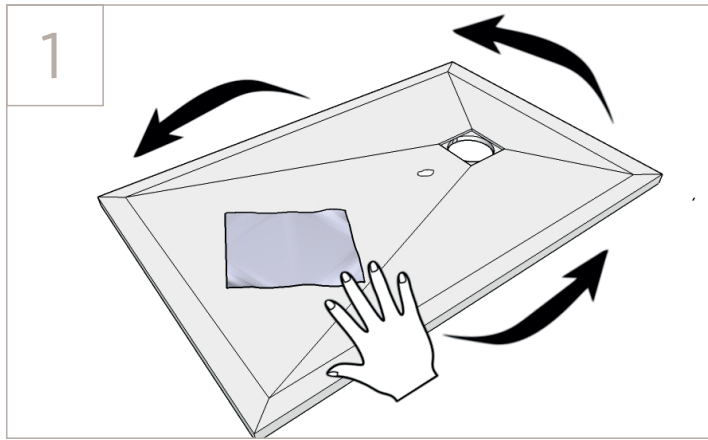

Contenu / Inhalt / Contenido / Contents / Contenuto



1 bac + 1 rouleau + 1 éponge à poncer + 3 bouteilles (revêtement, catalyseur, dissolvant) + 13m ruban adhésif

1 Eimer + 1 Rolle + 1 Waschlappen + 3 Flaschen (Beschichtung, Katalysator, Lösungsmittel) + 13m Abdeckklebeband

1 cubeta + 1 rodillo + 1 estropajo + 3 botellas (revestimiento, catalizador, disolvente) + 13m cinta de pintor

1 pail + 1 paint roller + 1 scourer + 3 bottles (covering, catalyst, solvent) + 13m masking tape

1 contenitore + 1 rullo + 1 spugna smerigliata + 3 bottiglie (rivestimento, catalizzatore, solvente) + 13m nastro per mascheratura

Mode d'emploi / Anwendungsvorschriften / Modo de empleo / Use manual / Istruzioni



Le produit doit rester sec pendant les 24 heures précédant l'intervention / Die Duschwanne muß 24 Stunden vor der Reparatur trocken bleiben / No humedecer el plato en las 24h previas / Keep the product dry 24 hours prior to the intervention / Non bagnare il piatto nelle 24 ore precedenti

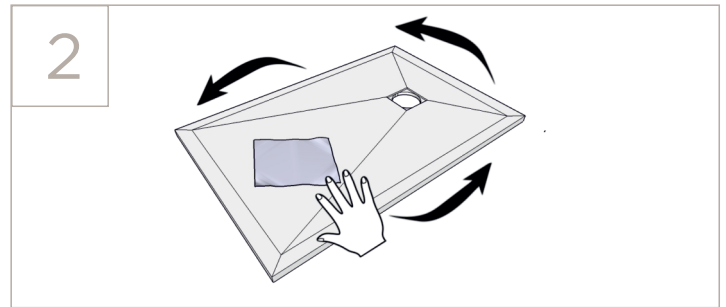
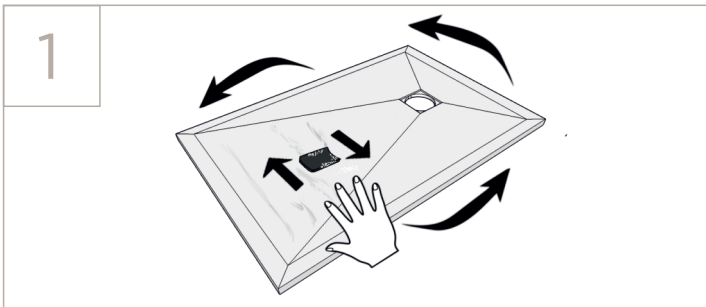

Nettoyer avec acétone / Wischen mit Aceton ab / Limpiar con acetona / Clean with acetone / Pulire con solvente

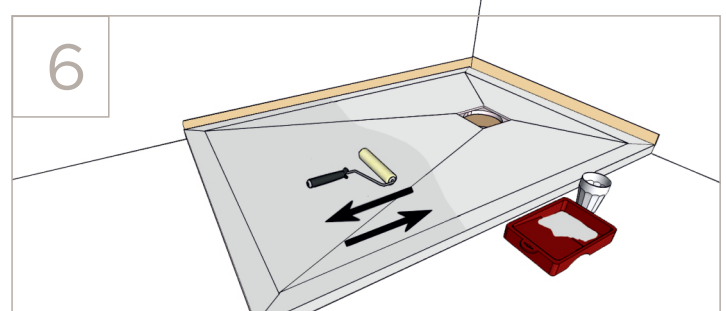
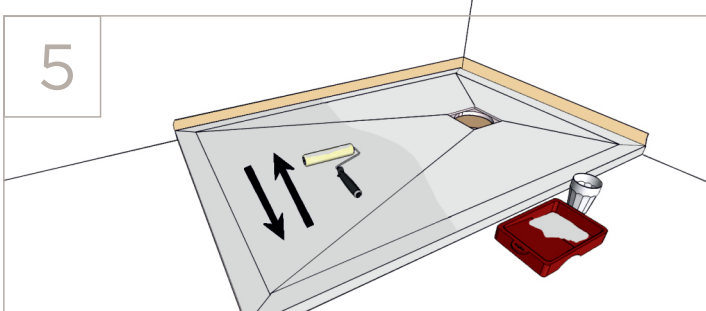
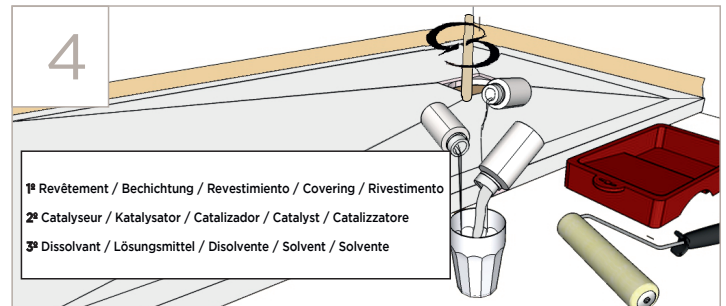
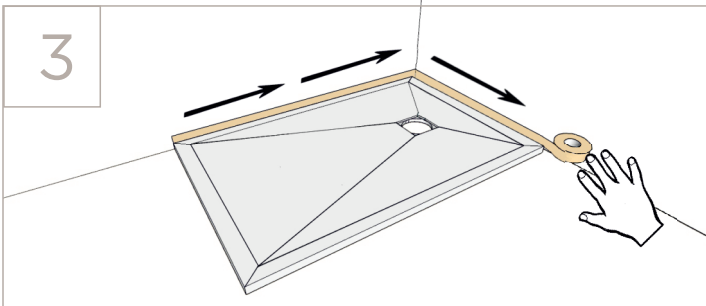

*Égoutter bien le rouleau avant l'application / Man muß die Rolle vor der Anwendung gut abtropfen lassen / Escurrir bien el rodillo antes de la aplicación / Drain properly the roller before the application / Scolare bene il rullo prima

