



SMART



B R E V E T É

FIXATION DE ROBINETTERIES



**L'ENCASTRÉ
FACILITÉ**

**FACILE.
RAPIDE.
SMART.**



**ENCASTREMENT
RAPIDE DES
MODULES**

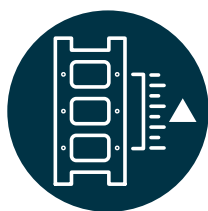

**POSITIONNEMENT
RÉGLABLE**

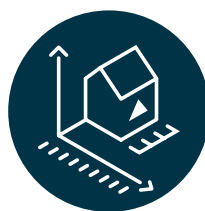

**SOUPLESSE
D'IMPLANTATION**



**ACCESSIBILITÉ
TOTALE**



SOLUTIONS • INNOVATIONS

FIXATION & RACCORDEMENT DE ROBINETTERIES ENCASTRÉES

LE CONCEPT

Fixer & raccorder toutes marques de robinetterie encastrée sur des montants d'entraxe 400 mm*. L'accès aux éléments encastrés est total grâce à l'absence de cloison durant toute l'installation.



**ENCASTREMENT
RAPIDE DES
MODULES**

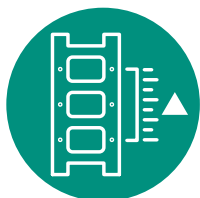

**POSITIONNEMENT
RÉGLABLE**

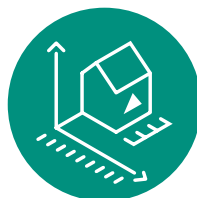

**SOUPLESSE
D'IMPLANTATION**



**ACCESSIBILITÉ
TOTALE**

ROBINETTERIES DE DOUCHE ENCASTRÉES

ROBINETTERIES DE LAVABO ENCASTRÉES



Positionnement instantané des modules par aimants



70 mm ou 100 mm



Coude douche
Positionnement possible à droite ou à gauche



SÉRIES 100 mm**

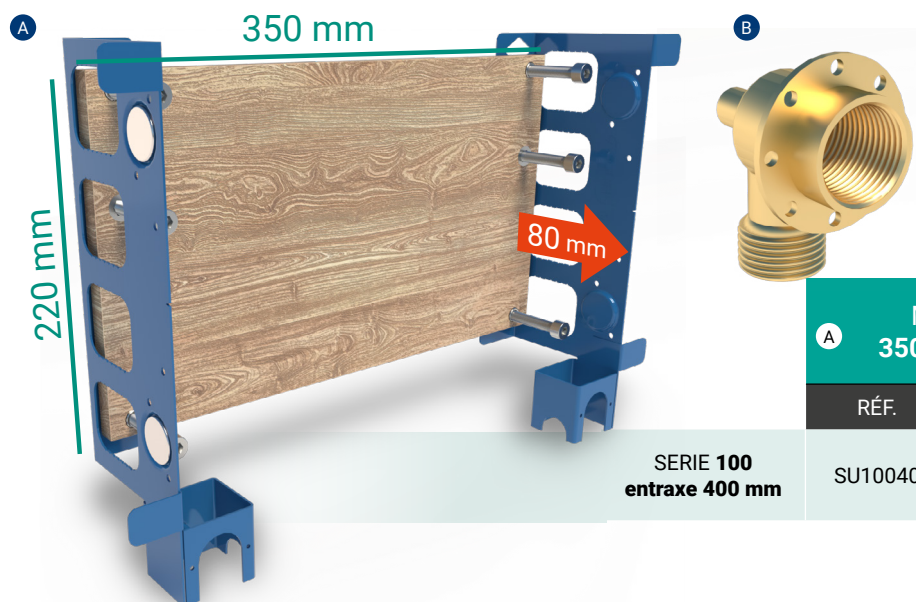

*VOIR PAGE 7

A MODULE 350 x 220 mm		B COUDE DOUCHETTE M&F 1/2	
RÉF.	QTE.	RÉF.	QTE.
SU10040	1	SC12	1

SERIE 100
entraxe 400 mm

SÉRIES 70 mm**

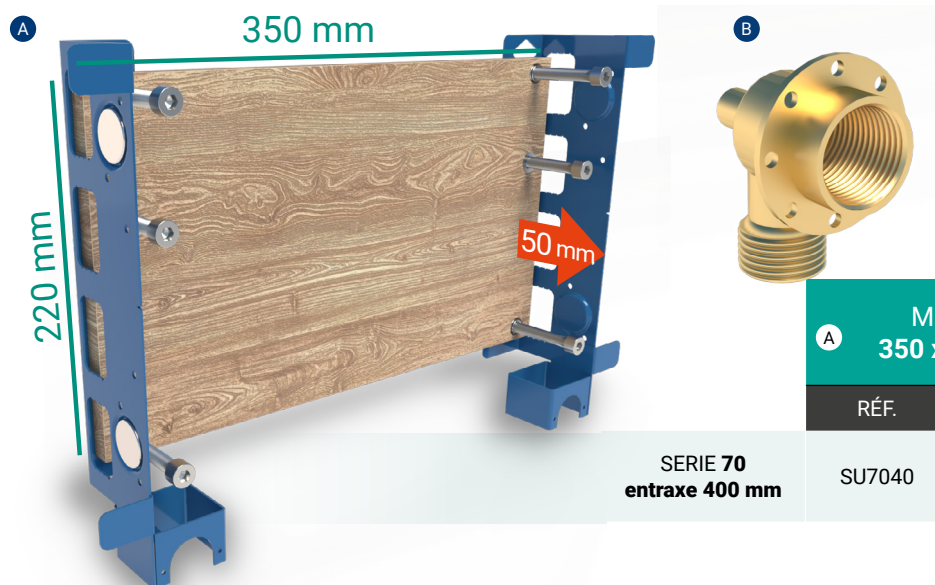

*VOIR PAGE 7

A MODULE 350 x 220 mm		B COUDE DOUCHETTE M&F 1/2	
RÉF.	QTE.	RÉF.	QTE.
SU7040	1	SC12	1

SERIE 70
entraxe 400 mm

LES AVANTAGES

**RACCORDEMENTS
ET ÉPREUVE
D'ÉTANCHÉITÉ AVANT
POSE DE LA CLOISON**

**SOUPLESSE
D'IMPLANTATION DES
MODULES**

**COUDES VISITABLES
MÊME APRÈS POSE DE
LA CLOISON CARRELÉE**
Garantie biennale

**En fonction de l'espace disponible sous plaque de plâtre

FIXATION & RACCORDEMENT D'ACCESSOIRES ENCASTRÉS

LE CONCEPT

Fixer & raccorder toutes marques d'accessoires de robinetterie encastrée sur des montants d'entraxe **400 mm***. L'accès aux éléments encastrés est total grâce à l'absence de cloison durant toute l'installation.



**ENCASTREMENT
RAPIDE DES
MODULES**

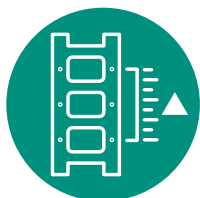

**POSITIONNEMENT
RÉGLABLE**

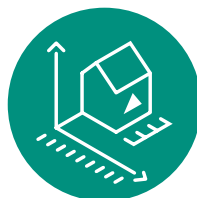

**SOUPLESSE
D'IMPLANTATION**



**ACCESSIBILITÉ
TOTALE**

3 UTILISATIONS POSSIBLES

1

DOUCHE DE TÊTE



2

CIEL DE PLUIE



3

DOUCHETTE



Positionnement instantané des modules par aimants

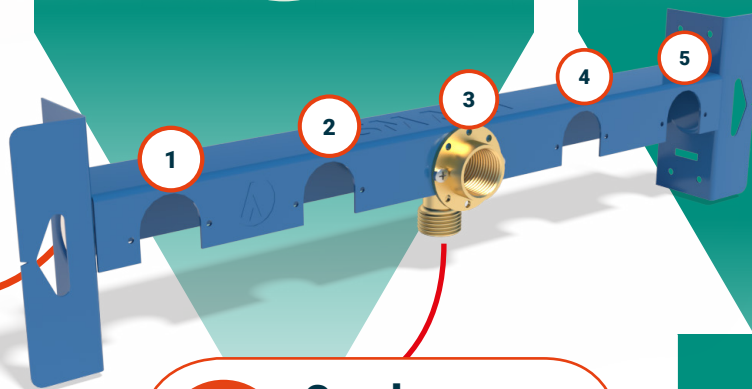

Coude
5 Positionnements possibles



MODULE MONO

RÉF.	QTE.
SM40	1

FIXATION & RACCORDEMENT DE ROBINETTERIES 150 OU 75 MM

LE CONCEPT

Fixer & raccorder toutes marques de robinetterie sur des montants d'entraxe 400 mm*.



**ENCASTREMENT
RAPIDE DES
MODULES**

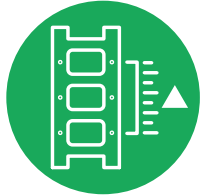

**POSITIONNEMENT
RÉGLABLE**

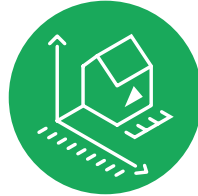

**SOUPLESSE
D'IMPLANTATION**



**ACCESSIBILITÉ
TOTALE**

150 MM

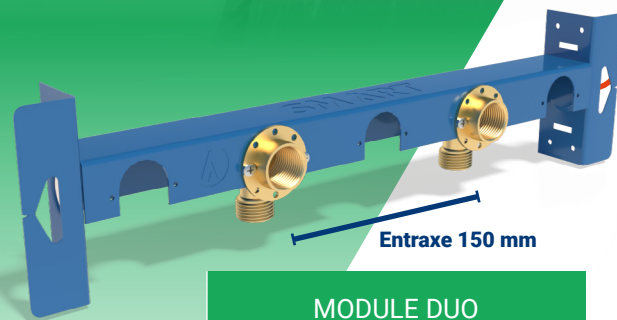
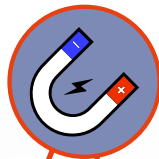

**MODULE DUO
ENTRAXE 150 mm**

RÉF.	QTE.
SE15040	1

entraxe 400 mm

SE15040

1

75 MM

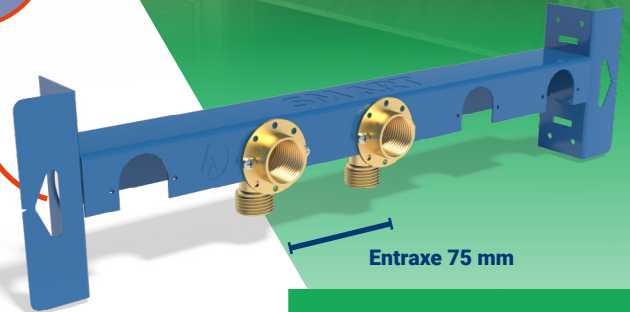

**MODULE DUO
ENTRAXE 75 mm**

RÉF.	QTE.
SE7540	1

entraxe 400 mm

SE7540

1

CONSEILS DE POSE ROBINETTERIES ENCASTRÉES

1

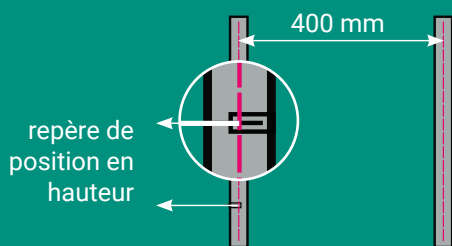

Repérer le positionnement des modules dans 1 ou 2 plans sur des montants d'entraxe de 400 mm. Positionner et fixer les modules.

2

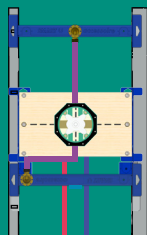

Fixer la robinetterie sur la plaque de bois. Raccorder les canalisations. Vérifier l'étanchéité.

3

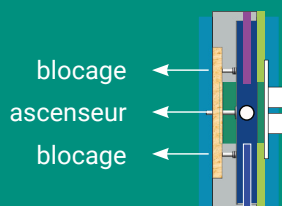

Effectuer le réglage d'affleurement de la box par rapport au revêtement de finition.

4

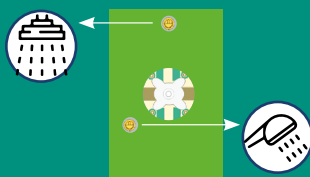

Découper et poser la plaque de plâtre. Poser le revêtement de finition.

5



Poser la plaque de finition et les organes de manœuvre.

CONSEILS DE POSE ACCESSOIRES - 150 MM - 75MM

1

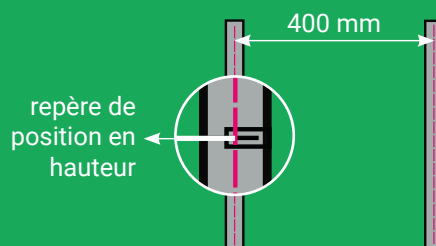

Repérer le positionnement des modules sur des montants d'entraxe de 400 mm.

2

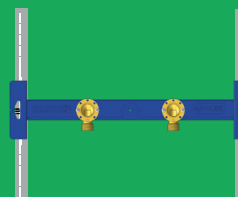

Positionner et fixer le module. Fixer le(s) raccord(s) rapide(s) sur les canalisations.

3

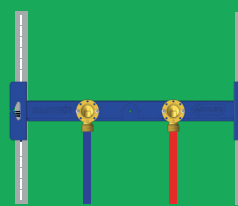

Raccorder la ou les canalisation(s). Vérifier l'étanchéité.

4

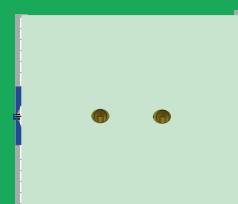

Percer la cloison à l'aide d'une scie cloche (Ø42mm) et la fixer.

5

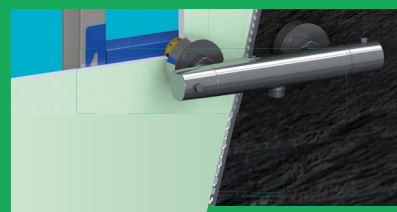

Poser le revêtement de finition. Poser l'accessoire ou la robinetterie



SÉCUR-FIT®

CONNECTION SÉCURISÉE PRÉCONISÉE TESTÉE À 30 BARS

ÉTANCHÉITÉ DES RACCORDEMENTS ASSURÉE PAR DOUBLE JOINT TORIQUE

MONTAGE SANS FILASSE NI TÉFLON (contraintes mécaniques résiduelles minimisées)

COUPLE DE SERRAGE DE L'ÉCROU MANUEL SANS OUTIL (0.5 DaN suffit)

BLOPAGE ÉCROU VERROUILLÉ (par clips d'arrêt pour palier aux vibrations et/ou aux chocs éventuels)

JOINT TORIQUE EPDM 70 SHORE A CERTIFIÉ ISO 9001

RACCORD EN LAITON 4 MS - CW617N

SERRAGE MANUEL
(SANS OUTIL)



SANS FILASSE



SANS OUTIL



SANS TÉFLON



VOIR LA PRÉSENTATION

CLIPS DE VERROUILLAGE

CONTRAINTES
MÉCANIQUES
AU SERRAGE
DES ÉCROUS

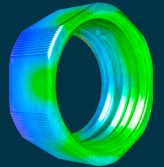

Serrage manuel
(environ 1 DaN)

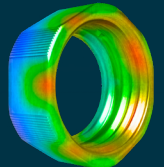

Serrage clé
(environ 5 DaN)



PER À GLISSEMENT

DIM.	RÉF.
12	SG12
16	SG16



À SOUDER

DIM.	RÉF.
14 & 16	SS1416



PER À SERTIR

DIM.	RÉF.
12	ST12
16	ST16



MULTICOUCHE U - H - TH

DIM.	RÉF.
16 X 2	SM16

POSSIBILITES DE RACCORDEMENT



SMART



ENCOCHE
DE RÉPÉRAGE

PROFONDEUR RÉGLABLE

AIMANTÉ

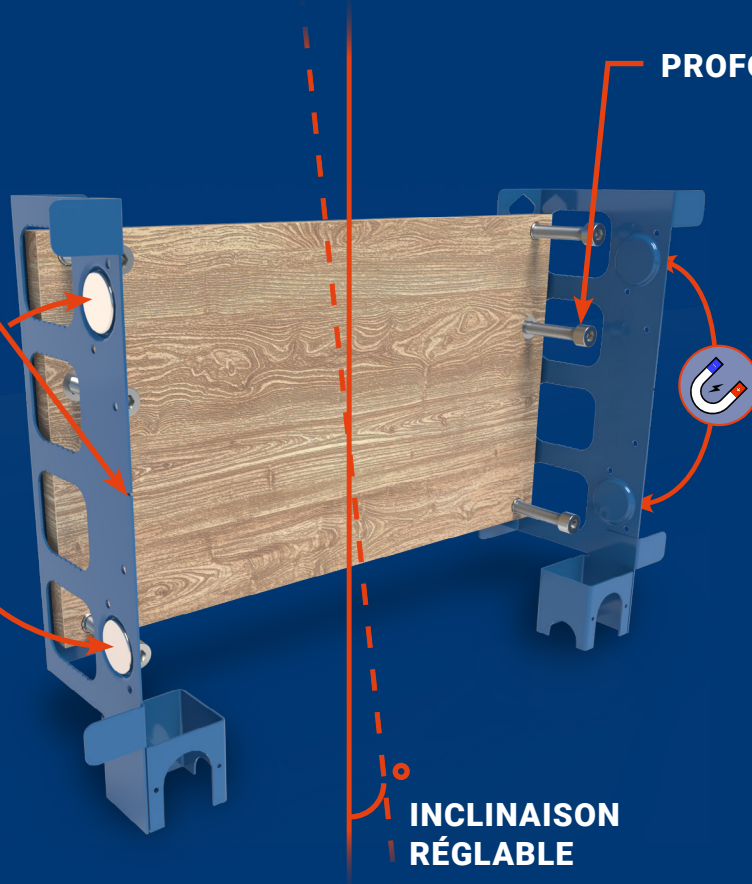

INCLINAISON
RÉGLABLE

**FACILE.
RAPIDE.
SMART.**



VOIR LA PRÉSENTATION

L'ENCASTRÉ FACILITÉ



**ENCASTREMENT
RAPIDE DES
MODULES**

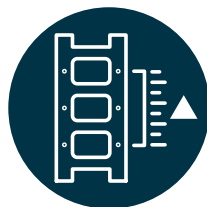

**POSITIONNEMENT
RÉGLABLE**

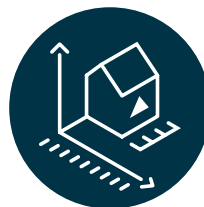

**SOUPLESSE
D'IMPLANTATION**



**ACCESSIBILITÉ
TOTALE**



909, route de Vaudricourt
80130 BOURSEVILLE

03.22.30.24.28
www.anquier.fr

